

CASING & BASE

BRUNSELL LUMBER & MILLWORK

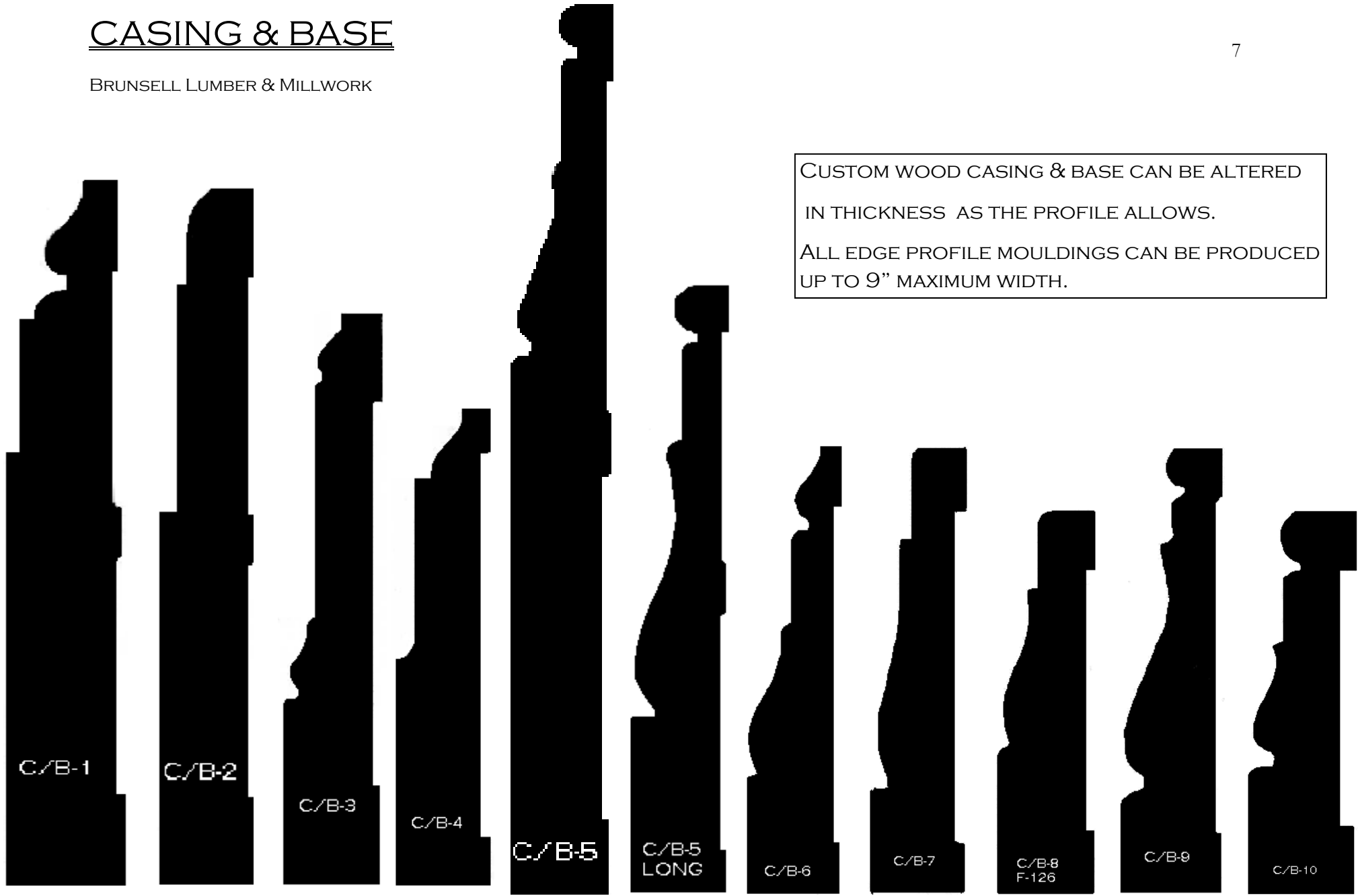

CUSTOM WOOD CASING & BASE CAN BE ALTERED
 IN THICKNESS AS THE PROFILE ALLOWS.
 ALL EDGE PROFILE MOULDINGS CAN BE PRODUCED
 UP TO 9" MAXIMUM WIDTH.

CB-1	CB-2	CB-3	CB-4	CB-5	CB-5L	CB-6	CB-7	CB-8	CB-9	CB-10
5-1/2"	5-1/2"	4-1/2"	3-3/4"	7"	4-3/4"	3-1/2"	3-5/8"	3"	3-1/2"	3"

CASING & BASE

BRUNSELL LUMBER & MILLWORK

CUSTOM WOOD CASING & BASE CAN BE ALTERED
 IN THICKNESS AS THE PROFILE ALLOWS.
 ALL EDGE PROFILE MOULDINGS CAN BE PRODUCED
 UP TO 9" MAXIMUM WIDTH.



CB-11

CB-12

CB-13

CB-14

CB-15

CB-16

CB-17

CB-18

CB-19

CB-20

7"

7"

9"MAX

9"MAX

9"MAX

3 - 3/4"

9"MAX

2 - 1/4"

9"MAX

3 - 3/4"

F-161

CASING & BASE

BRUNSELL LUMBER & MILLWORK

CUSTOM WOOD CASING & BASE CAN BE ALTERED
 IN THICKNESS AS THE PROFILE ALLOWS.
 ALL EDGE PROFILE MOULDINGS CAN BE PRODUCED
 UP TO 9" MAXIMUM WIDTH.

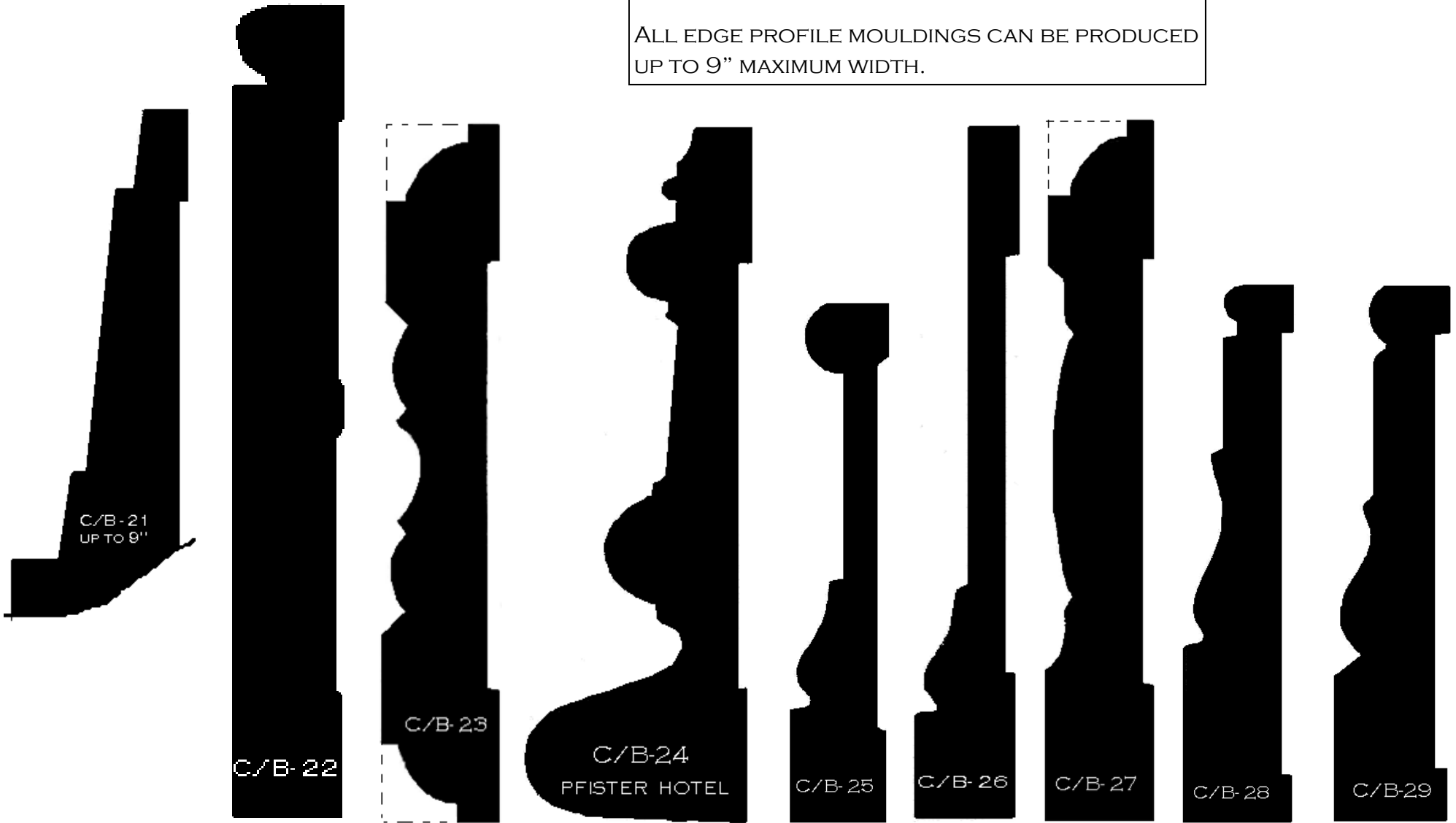

CB-21	CB-22	CB-23	CB-24	CB-25	CB-26	CB-27	CB-28	CB-29
9" MAX	5-3/4"	5"	5"	3-3/4"	5"	5"	3-3/4"	3-3/4"

CASING & BASE

BRUNSELL LUMBER & MILLWORK

CUSTOM WOOD CASING & BASE CAN BE ALTERED
 IN THICKNESS AS THE PROFILE ALLOWS.
 ALL EDGE PROFILE MOULDINGS CAN BE PRODUCED
 UP TO 9" MAXIMUM WIDTH.

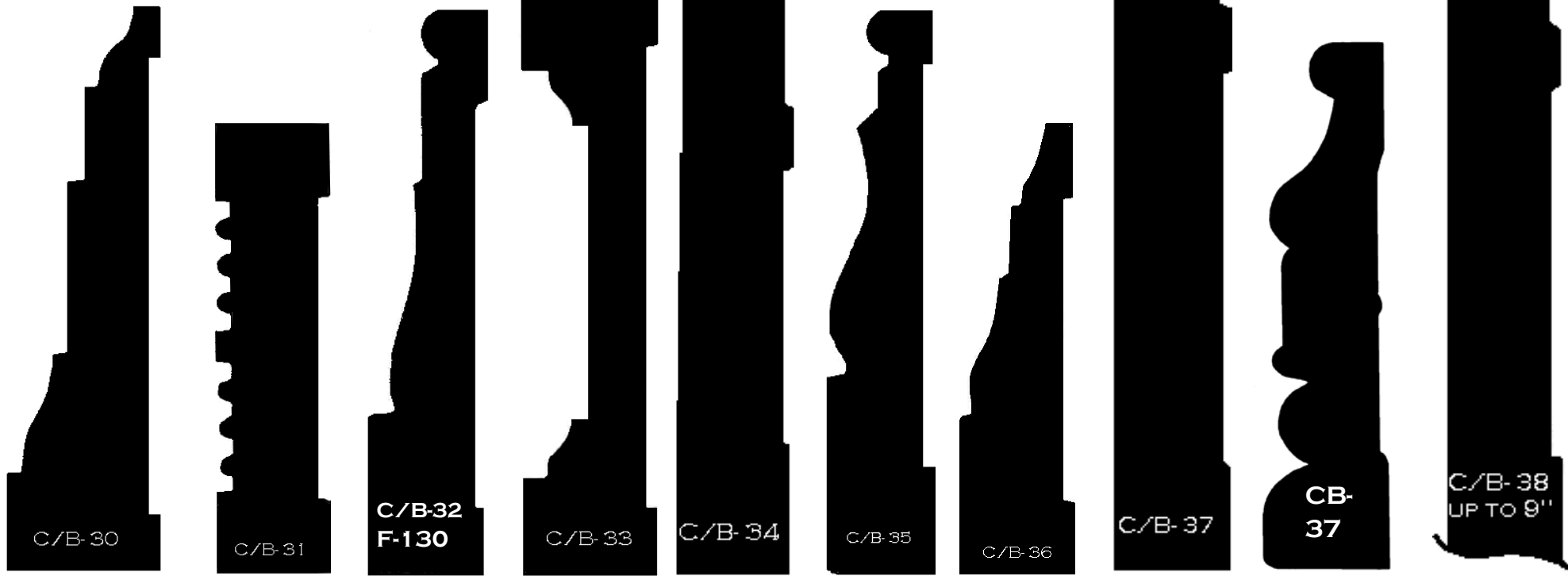

CB-30	CB-31	CB-32	CB-33	CB-34	CB-35	CB-36	CB-37	CB-37	CB-38
3 - 3/4"	3"	3 - 3/4"	4"	5 - 3/4"	3 - 3/4"	3"	7"	3-1/2"	9"MAX
		F-130						SHORT	

CASING & BASE

BRUNSELL LUMBER & MILLWORK

CUSTOM WOOD CASING & BASE CAN BE ALTERED
 IN THICKNESS AS THE PROFILE ALLOWS.
 ALL EDGE PROFILE MOULDINGS CAN BE PRODUCED
 UP TO 9" MAXIMUM WIDTH.

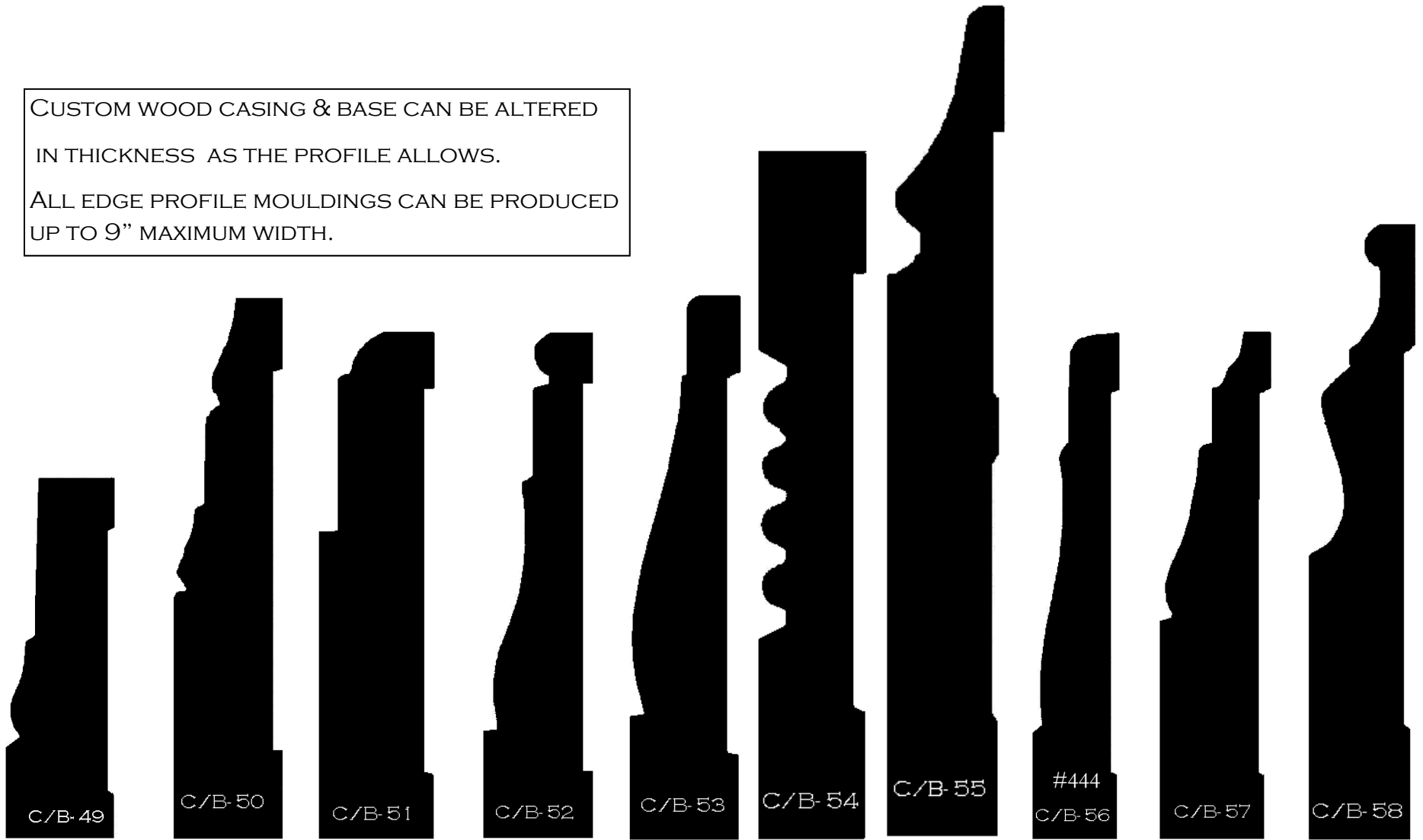

CB-49	CB-50	CB-51	CB-52	CB-53	CB-54	CB-55	CB-56	CB-57	CB-58
2 -1/2"	3 -3/4"	3 -1/2"	3 -1/2"	3 -3/4"	4 -3/4"	5 -3/4"	3 -1/2"	3 -1/2"	4 -1/4"

#444

CASING & BASE

BRUNSELL LUMBER & MILLWORK

CUSTOM WOOD CASING & BASE CAN BE ALTERED
IN THICKNESS AS THE PROFILE ALLOWS.
ALL EDGE PROFILE MOULDINGS CAN BE PRODUCED
UP TO 9" MAXIMUM WIDTH.

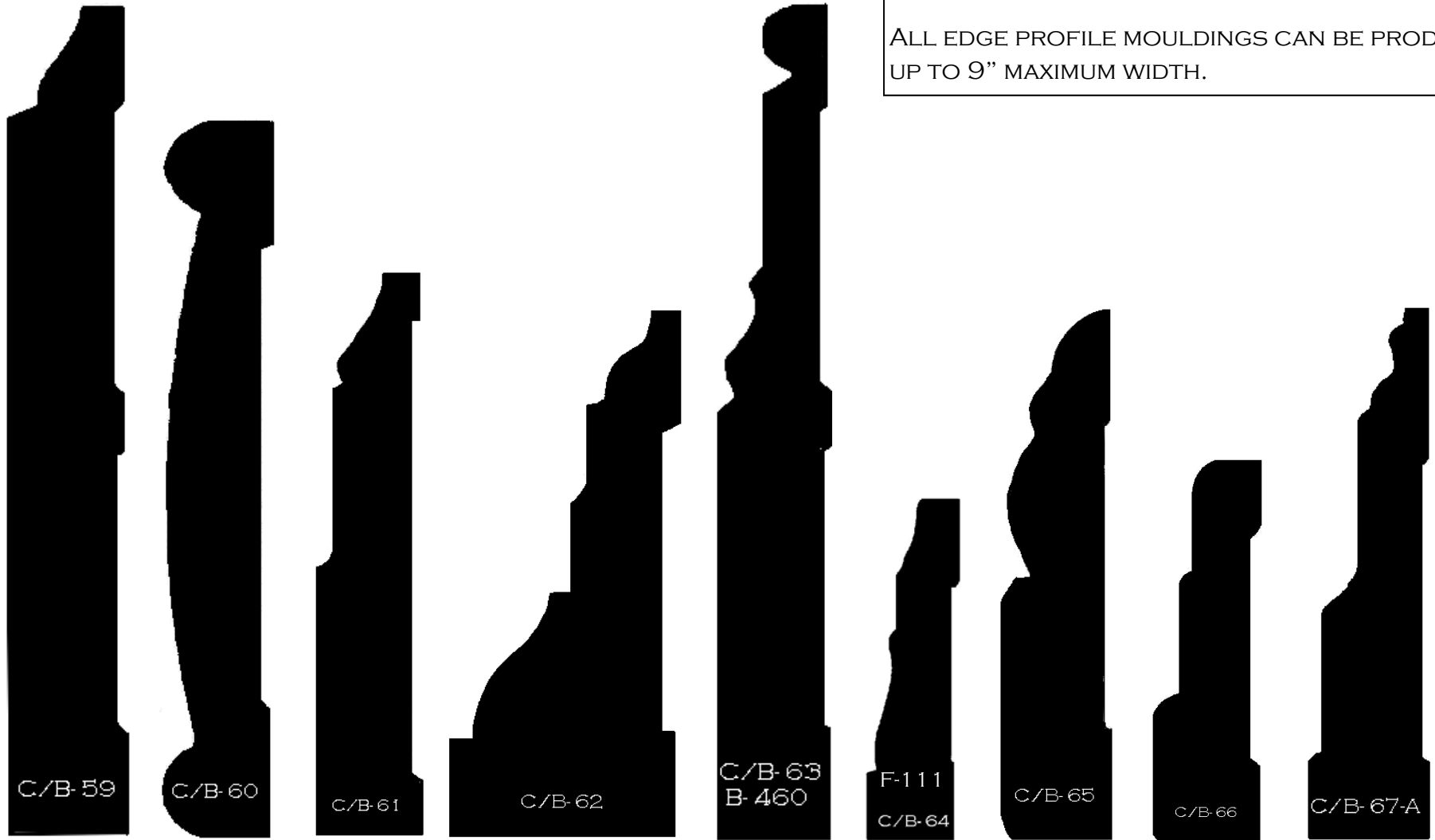

CB-59	CB-60	CB-61	CB-62	CB-63	CB-64	CB-65	CB-66	CB-67-A
5 -1/2"	4 -3/4"	3 -3/4"	3 -1/2"	5 -1/2"	2 -1/4"	3 -1/2"	2 -1/2"	3 -1/2"

F-111

CUSTOM WOOD CASING & BASE CAN BE ALTERED
 IN THICKNESS AS THE PROFILE ALLOWS.
 ALL EDGE PROFILE MOULDINGS CAN BE PRODUCED
 UP TO 9" MAXIMUM WIDTH.

CASING & BASE

BRUNSELL LUMBER & MILLWORK

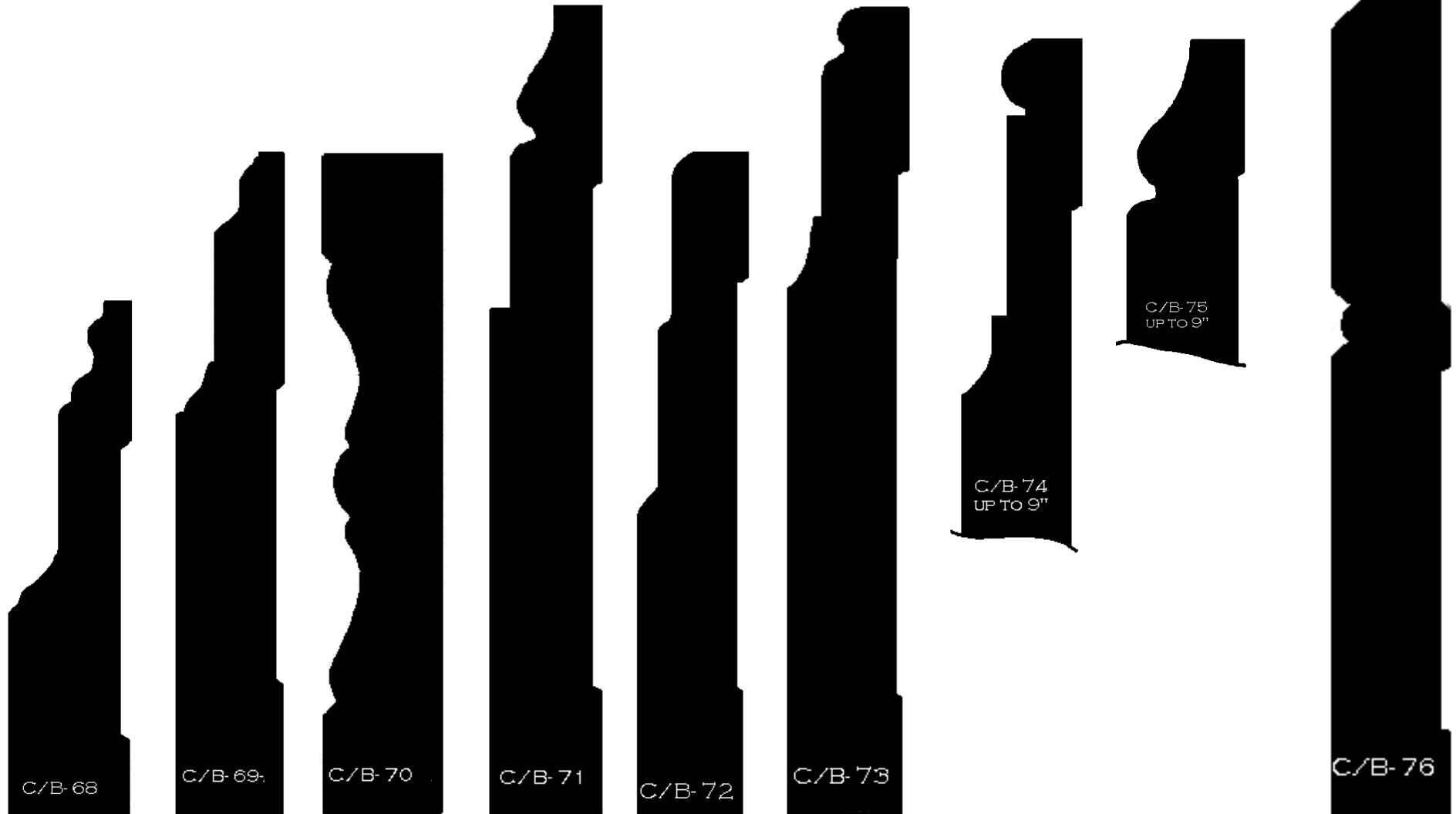

CB-68	CB-69	CB-70	CB-71	CB-72	CB-73	CB-74	CB-75	CB-76
3 -1/2"	4 -1/2"	4 -1/2"	5 -1/2"	4 -1/2"	5 -1/2"	9"MAX	9" MAX	7"

CASING & BASE

BRUNSELL LUMBER & MILLWORK

15

CUSTOM WOOD CASING & BASE CAN BE ALTERED

IN THICKNESS AS THE PROFILE ALLOWS.

ALL EDGE PROFILE MOULDINGS CAN BE PRODUCED
UP TO 9" MAXIMUM WIDTH.

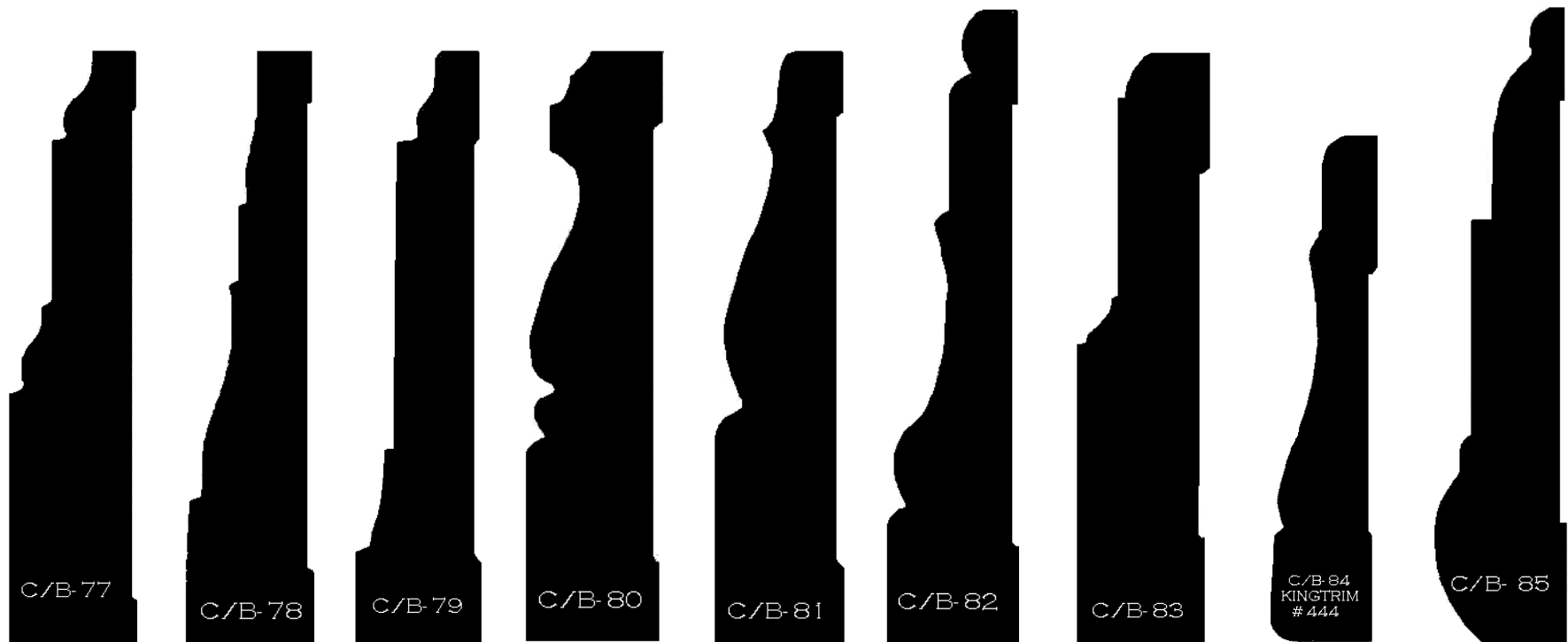

CB-77

CB-78

CB-79

CB-80

CB-81

CB-82

CB-83

CB-84

CB-85

3 -1/2"

3 -1/2"

3 -1/2"

3 -1/2"

3 -1/2"

3 -3/4"

3 -1/2"

3"

3 -3/4"

#444

CASING & BASE

BRUNSELL LUMBER & MILLWORK

CUSTOM WOOD CASING & BASE CAN BE ALTERED
 IN THICKNESS AS THE PROFILE ALLOWS.
 ALL EDGE PROFILE MOULDINGS CAN BE PRODUCED
 UP TO 9" MAXIMUM WIDTH.

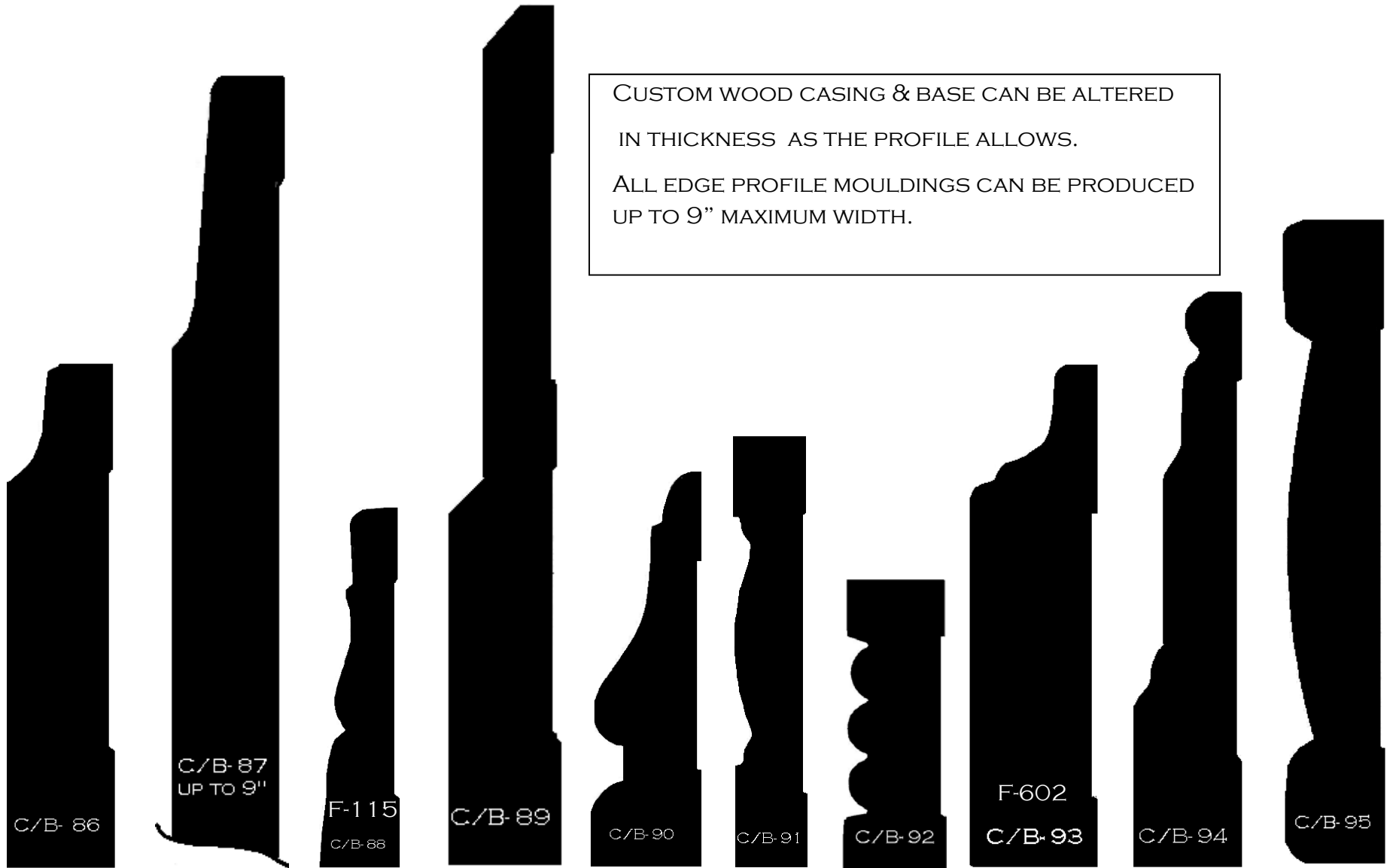

CB-86	CB-87	CB-88	CB-89	CB-90	CB-91	CB-92	CB-93	CB-94	CB-95
3 -1/2"	9" MAX	2 -1/2"	6"	2 -3/4"	3"	2"	3 -1/2"	4"	4 -1/2"
		F-115					F-602		

CASING & BASE

BRUNSELL LUMBER & MILLWORK

CUSTOM WOOD CASING & BASE CAN BE ALTERED
IN THICKNESS AS THE PROFILE ALLOWS.
ALL EDGE PROFILE MOULDINGS CAN BE PRODUCED
UP TO 9" MAXIMUM WIDTH.

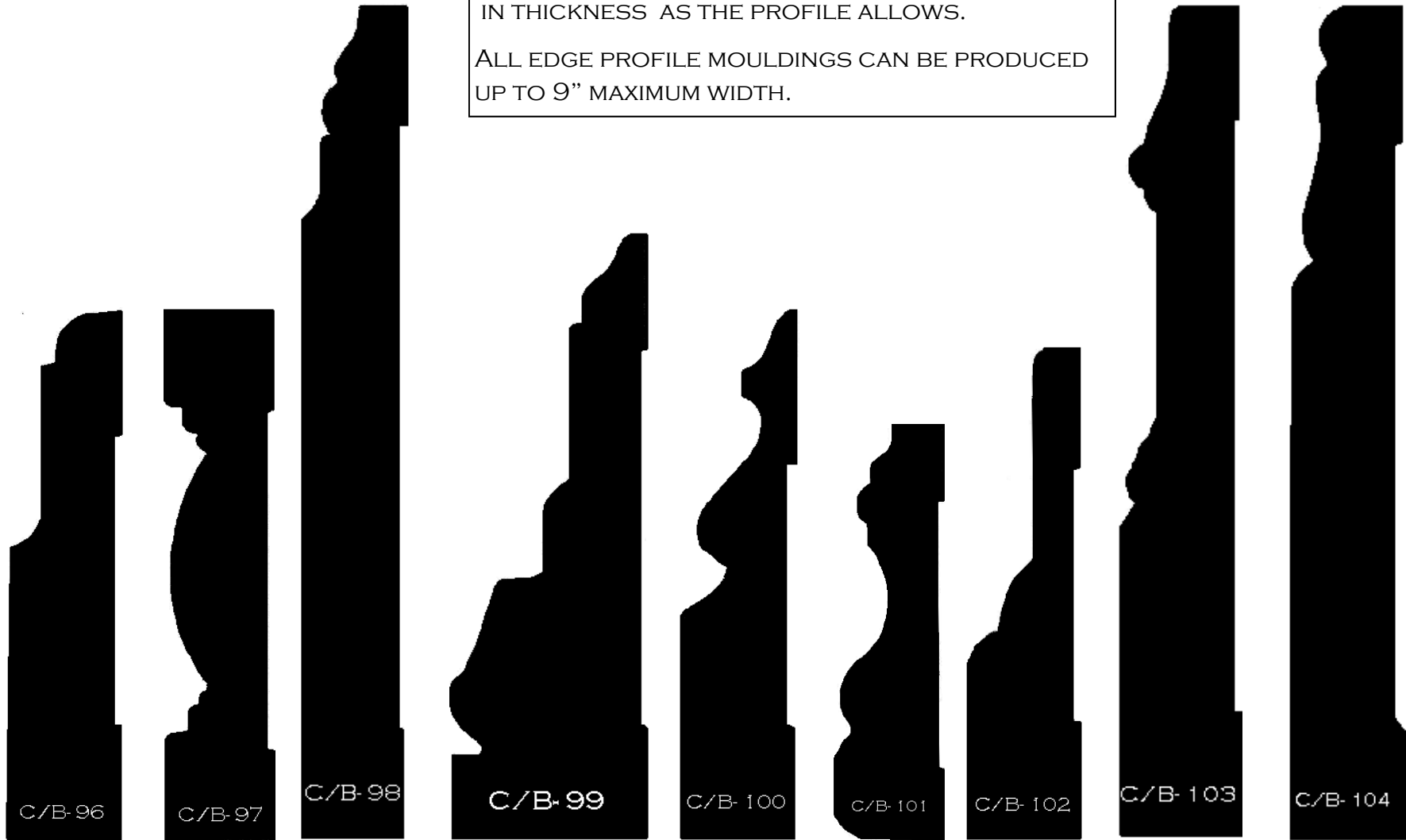

CB-96	CB-97	CB-98	CB-99	CB-100	CB-101	CB-102	CB-103	CB-104
3 -1/2"	3 -1/2"	5 -1/2"	4"	3 -1/2"	2 -3/4"	3 -1/4"	5 -1/2"	5 -1/2"

CASING & BASE

BRUNSELL LUMBER & MILLWORK

CUSTOM WOOD CASING & BASE CAN BE ALTERED
IN THICKNESS AS THE PROFILE ALLOWS.
ALL EDGE PROFILE MOULDINGS CAN BE PRODUCED
UP TO 9" MAXIMUM WIDTH.

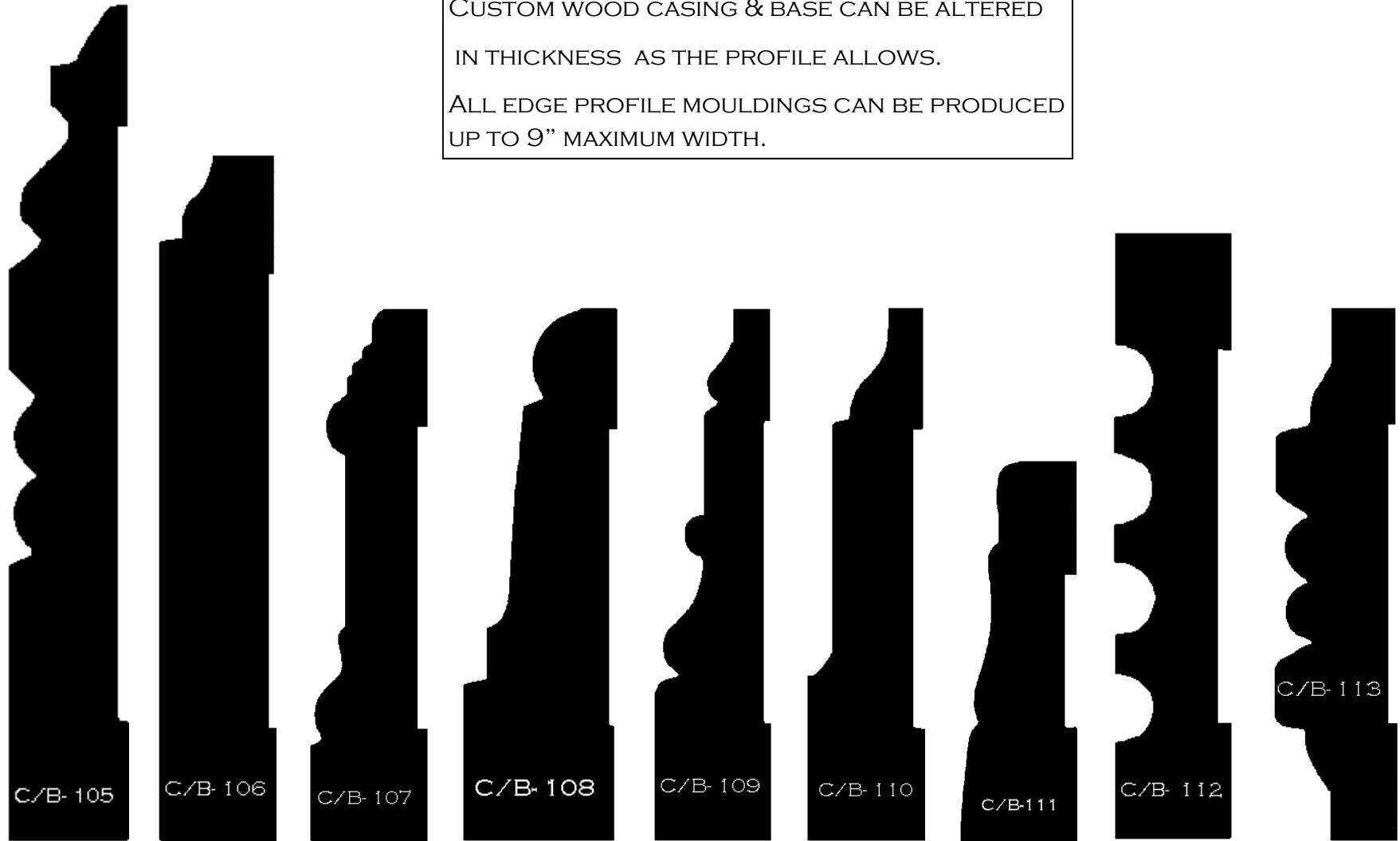

CB-105	CB-106	CB-107	CB-108	CB-109	CB-110	CB-111	CB-112	CB-113
5 -1/2"	4 -1/2"	3 -1/2"	3 -1/2"	3 -1/2"	3 -1/2"	2 -1/2"	4"	3 -1/2"

CASING & BASE

BRUNSELL LUMBER & MILLWORK

CUSTOM WOOD CASING & BASE CAN BE ALTERED
IN THICKNESS AS THE PROFILE ALLOWS.
ALL EDGE PROFILE MOULDINGS CAN BE PRODUCED
UP TO 9" MAXIMUM WIDTH.

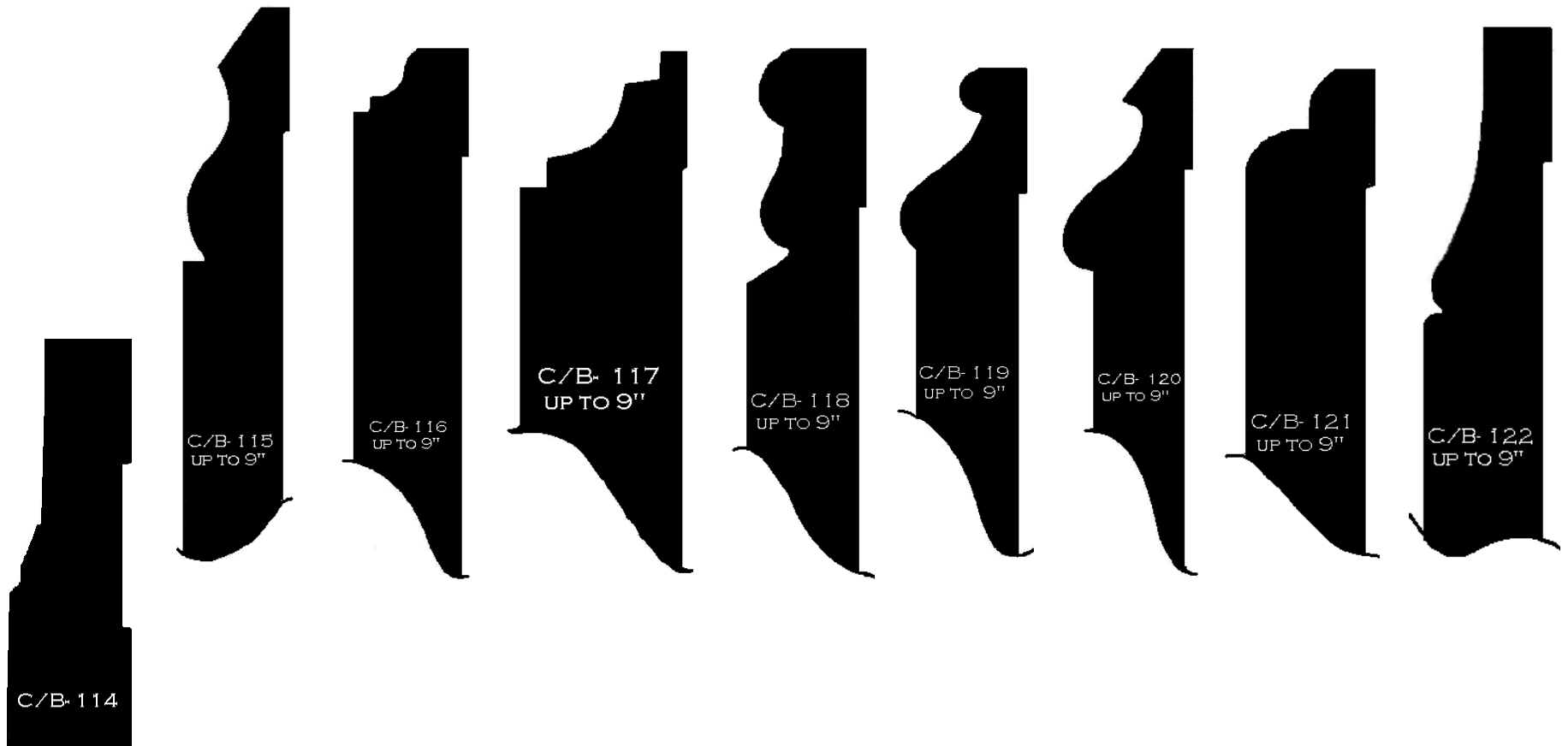

CB-114	CB-115	CB-116	CB-117	CB-118	CB-119	CB-120	CB-121	CB-122
2 -1/2"	9"MAX	9" MAX	9"MAX	9" MAX	9"MAX	9" MAX	9"MAX	9" MAX

CASING & BASE

BRUNSELL LUMBER & MILLWORK

CUSTOM WOOD CASING & BASE CAN BE ALTERED
IN THICKNESS AS THE PROFILE ALLOWS.
ALL EDGE PROFILE MOULDINGS CAN BE PRODUCED
UP TO 9" MAXIMUM WIDTH.

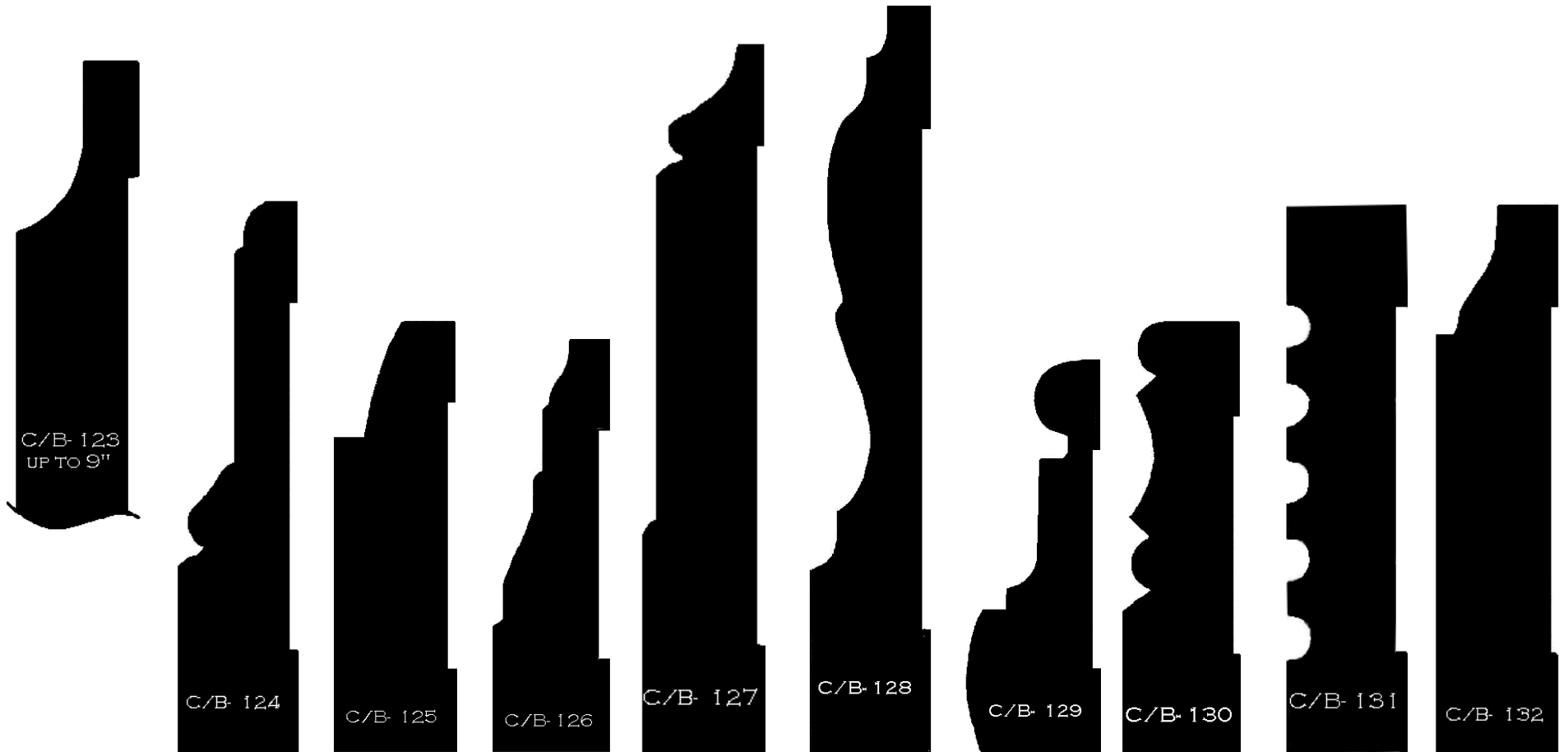

CB-123	CB-124	CB-125	CB-126	CB-127	CB-128	CB-129	CB-130	CB-131	CB-132
9" MAX	3 1/2"	2 3/4"	2 5/8"	4 1/2"	4 3/4"	2 1/2"	2 3/4"	3 1/2"	3 1/2"

CASING & BASE

BRUNSELL LUMBER & MILLWORK

CUSTOM WOOD CASING & BASE CAN BE ALTERED
IN THICKNESS AS THE PROFILE ALLOWS.
ALL EDGE PROFILE MOULDINGS CAN BE PRODUCED
UP TO 9" MAXIMUM WIDTH.

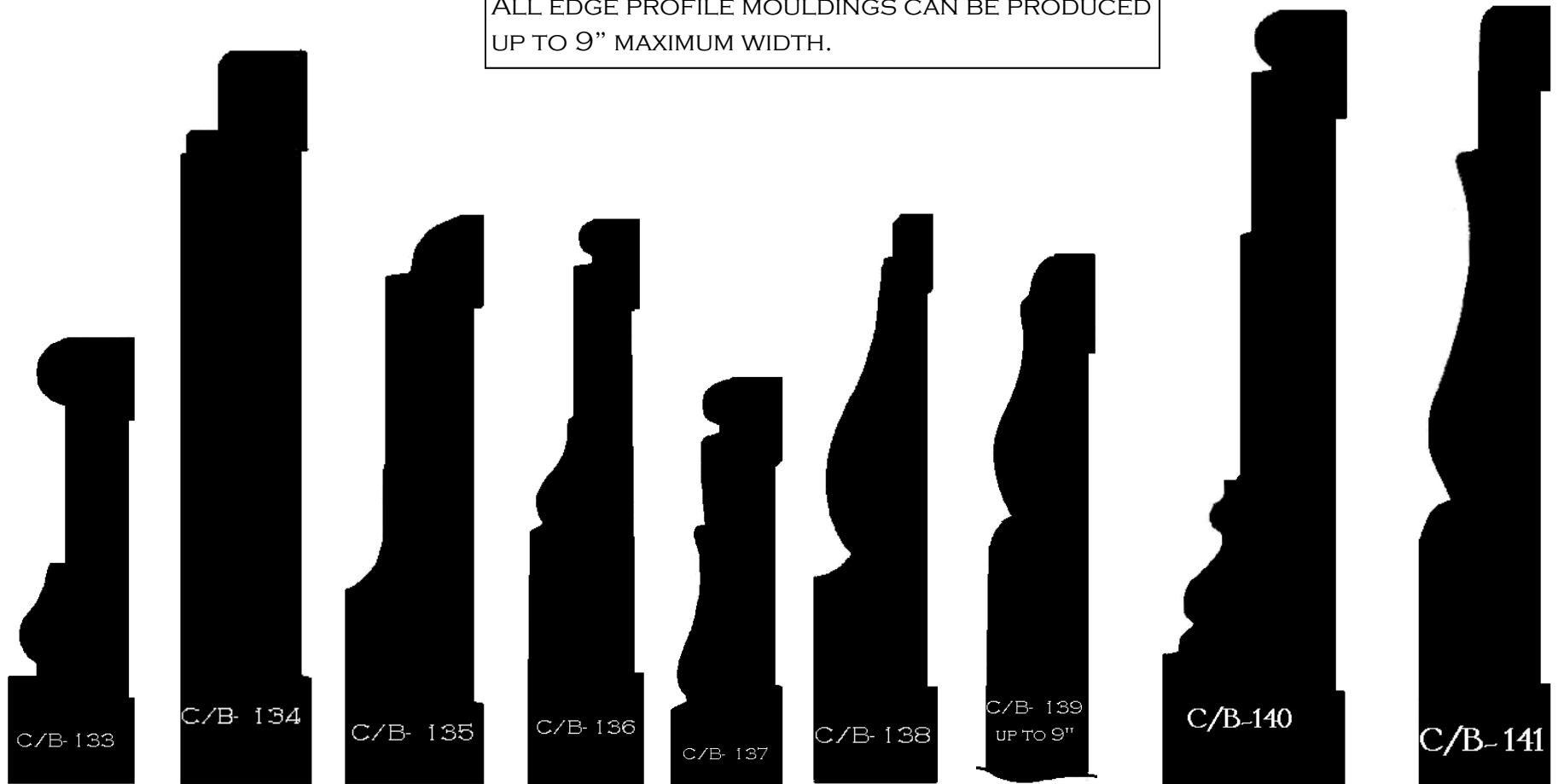

CB133	CB-134	CB-135	CB-136	CB-137	CB-138	CB-139	CB-140	CB-141
2 -3/4"	4 -1/2"	3 -1/2"	3 -1/2"	2 -1/2"	3 -1/2"	3 -1/4"	4 -3/4"	4 -3/4"

CASING & BASE

BRUNSELL LUMBER & MILLWORK

CUSTOM WOOD CASING & BASE CAN BE ALTERED
IN THICKNESS AS THE PROFILE ALLOWS.
ALL EDGE PROFILE MOULDINGS CAN BE PRODUCED
UP TO 9" MAXIMUM WIDTH.

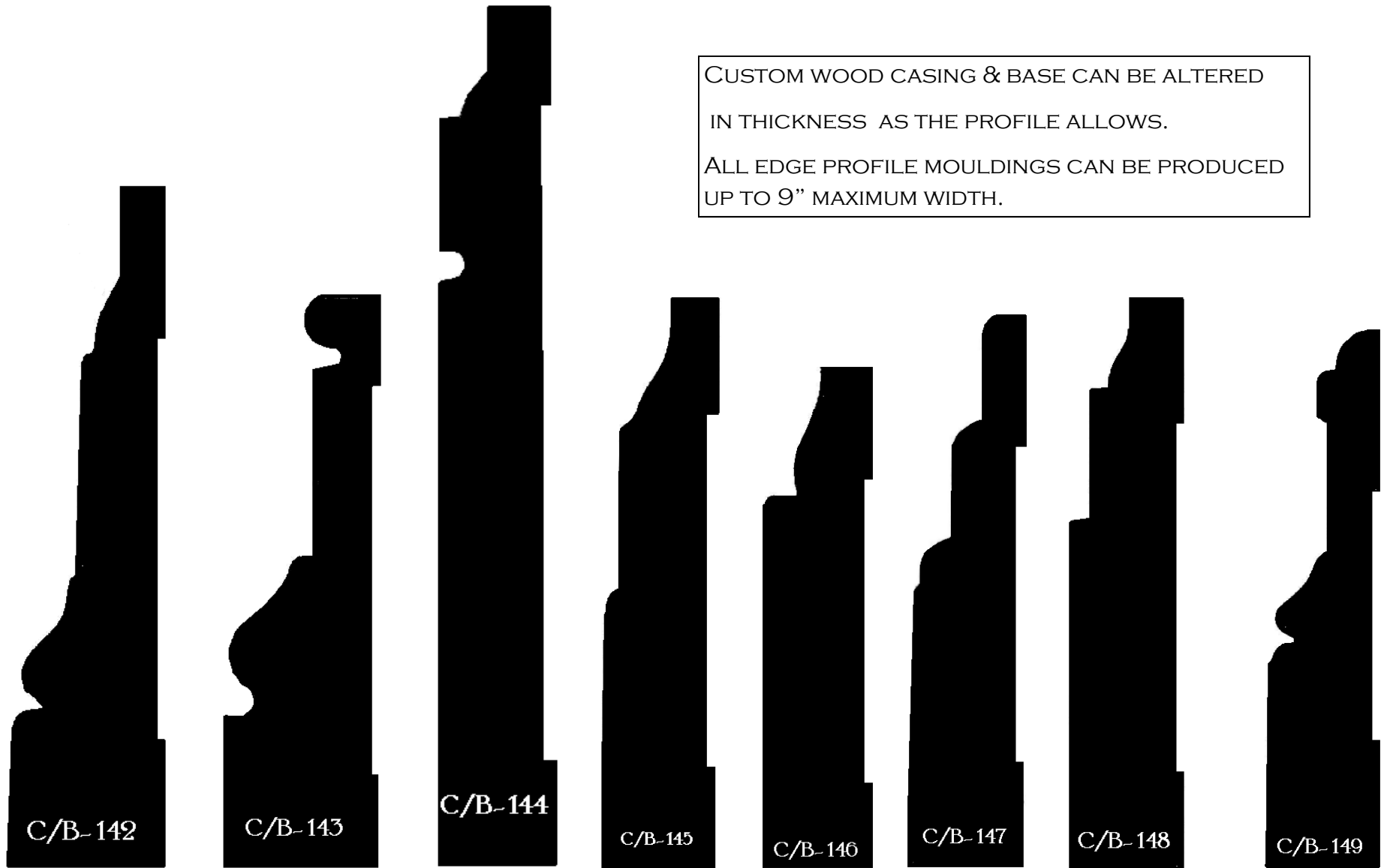

CB-142

CB-143

CB-144

CB-145

CB-146

CB-147

CB-148

CB-149

4 -3/4"

4"

6"

4"

3 -1/2"

3 -3/4"

4"

3 -3/4"

CASING & BASE

BRUNSELL LUMBER & MILLWORK

CUSTOM WOOD CASING & BASE CAN BE ALTERED
IN THICKNESS AS THE PROFILE ALLOWS.
ALL EDGE PROFILE MOULDINGS CAN BE PRODUCED
UP TO 9" MAXIMUM WIDTH.

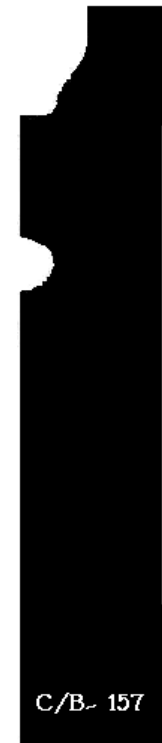

CB-150

CB-151

CB-152

CB-153

CB-154

CB-155

CB-156

CB-157

3 -7/8"

3 -7/8"

3 -1/2"

3 -3/4"

6"

6"

3 -5/8"

3 -3/4"

CASING & BASE

BRUNSELL LUMBER & MILLWORK

CUSTOM WOOD CASING & BASE CAN BE ALTERED
IN THICKNESS AS THE PROFILE ALLOWS.
ALL EDGE PROFILE MOULDINGS CAN BE PRODUCED
UP TO 9" MAXIMUM WIDTH.

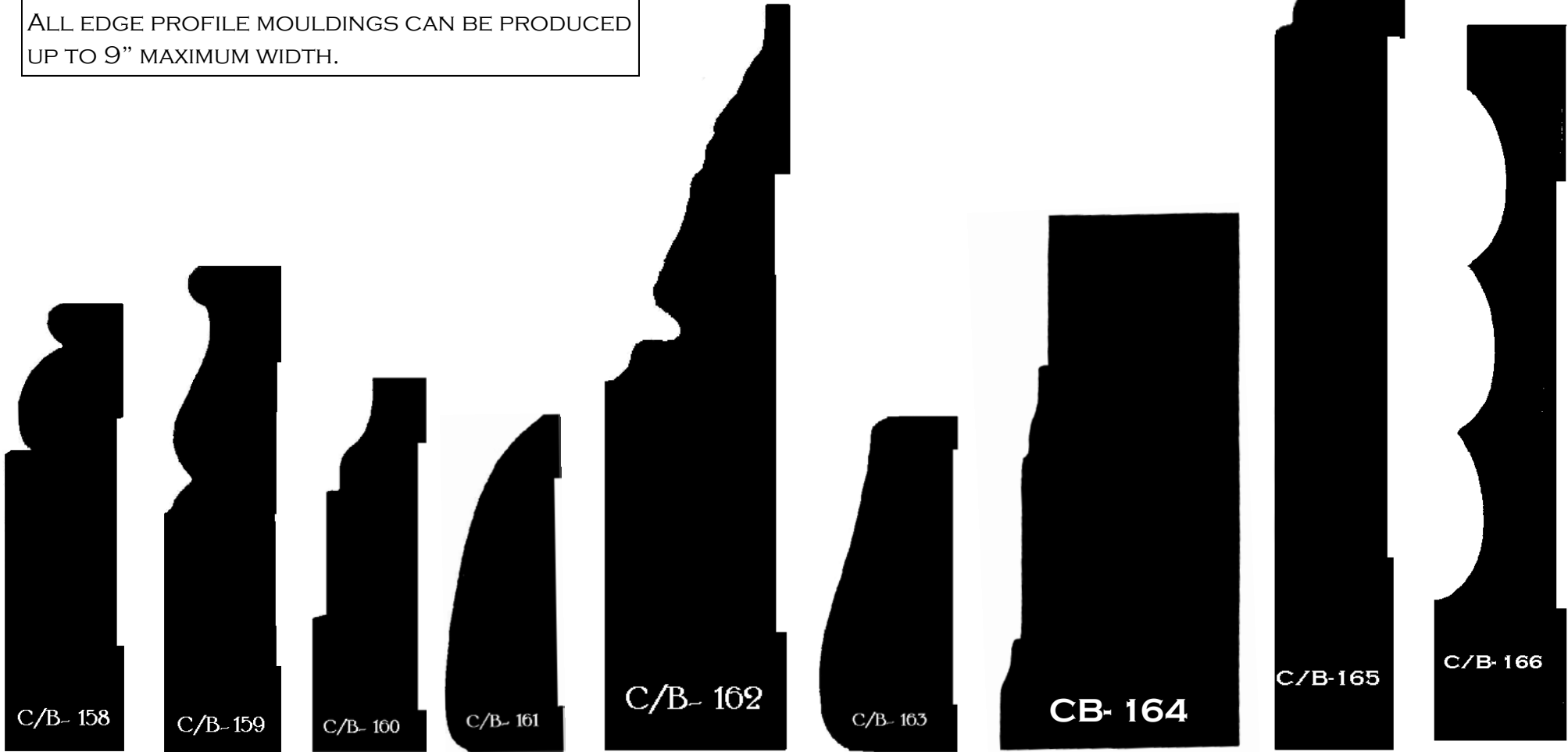

CB-158	CB-159	CB-160	CB-161	CB-162	CB-163	CB-164	CB-165	CB-166
3"	3 -1/4"	2 -1/2"	2 -1/4"	5"	2 -1/4"	3-1/2"	6"	4 -7/8"

CASING & BASE

BRUNSELL LUMBER & MILLWORK

CUSTOM WOOD CASING & BASE CAN BE ALTERED
IN THICKNESS AS THE PROFILE ALLOWS.
ALL EDGE PROFILE MOULDINGS CAN BE PRODUCED
UP TO 9" MAXIMUM WIDTH.

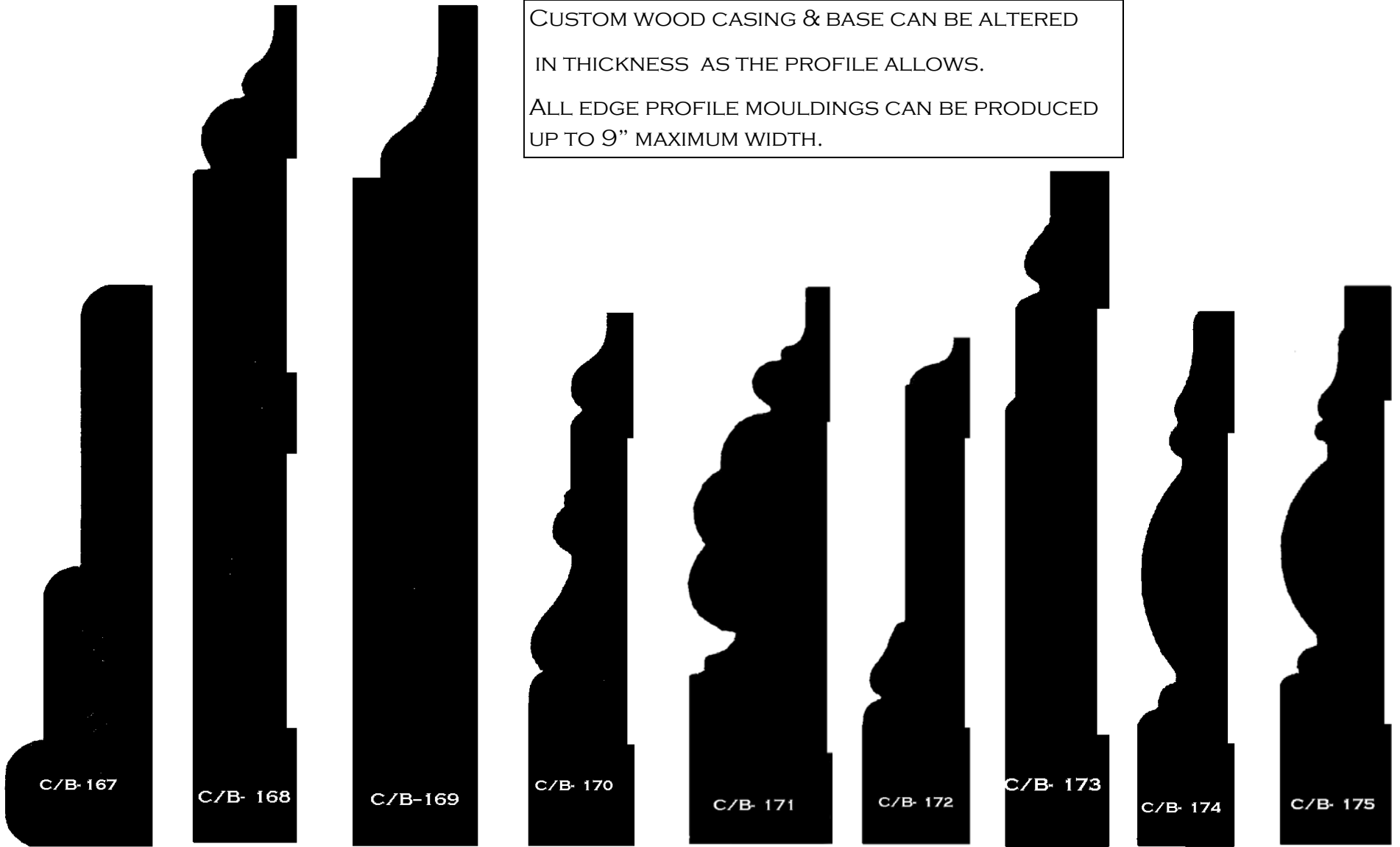

CB-167	CB-168	CB-169	CB-170	CB-171	CB-172	CB-173	CB-174	CB-175
4"	6"	6"	3 -5/8"	4"	3 -5/8"	4 -7/8"	3 -7/8"	4"

CASING & BASE

BRUNSELL LUMBER & MILLWORK

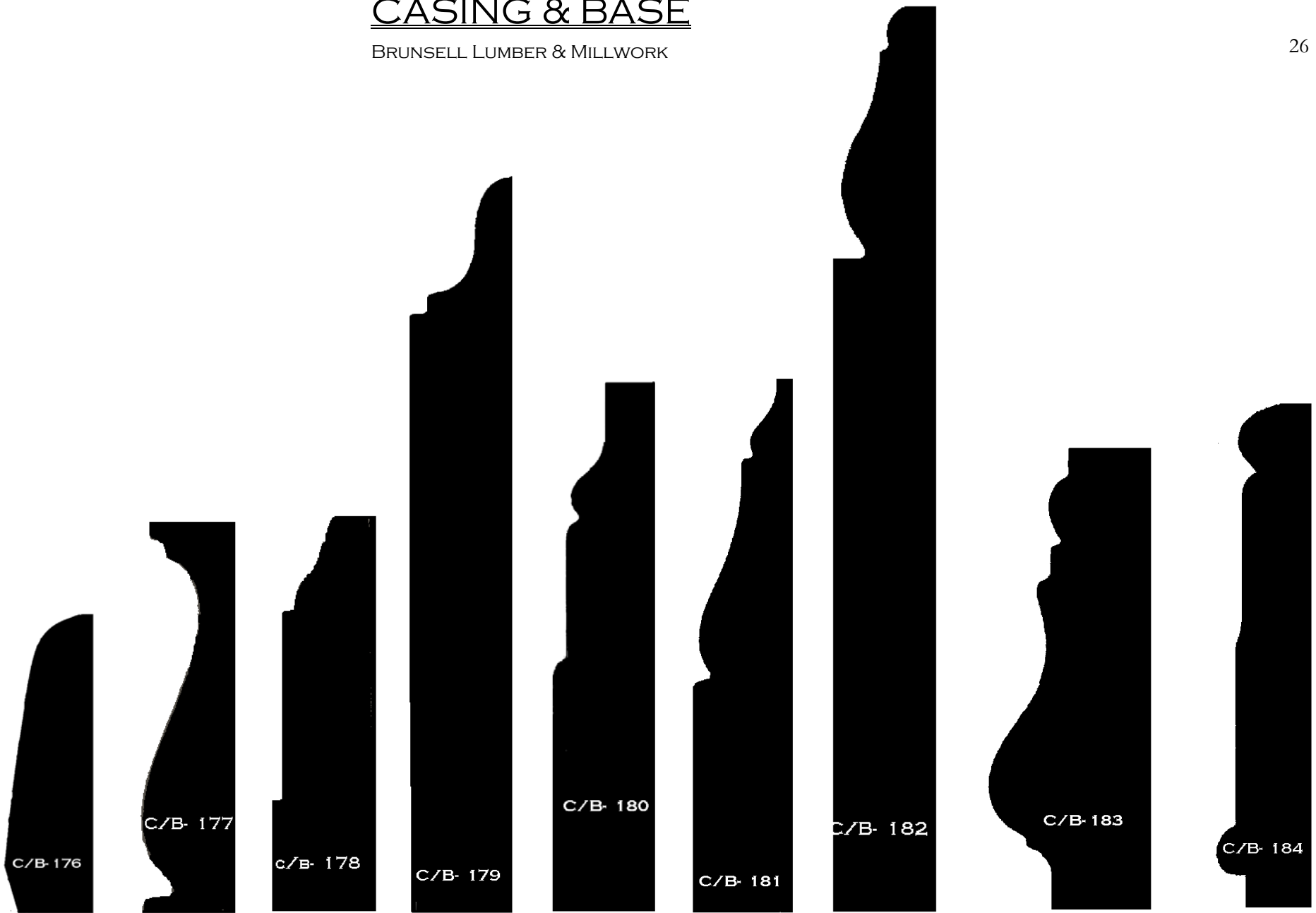

CB-176	CB-177	CB-178	CB-179	CB-180	CB-181	CB-182	CB-183	CB-184
2 -1/4"	2 -7/8"	3"	5 -1/2"	4"	4"	6 -3/4"	3 -1/2"	3 -3/4"

CASING & BASE

BRUNSELL LUMBER & MILLWORK

CUSTOM WOOD CASING & BASE CAN BE ALTERED
IN THICKNESS AS THE PROFILE ALLOWS.
ALL EDGE PROFILE MOULDINGS CAN BE PRODUCED
UP TO 9" MAXIMUM WIDTH.

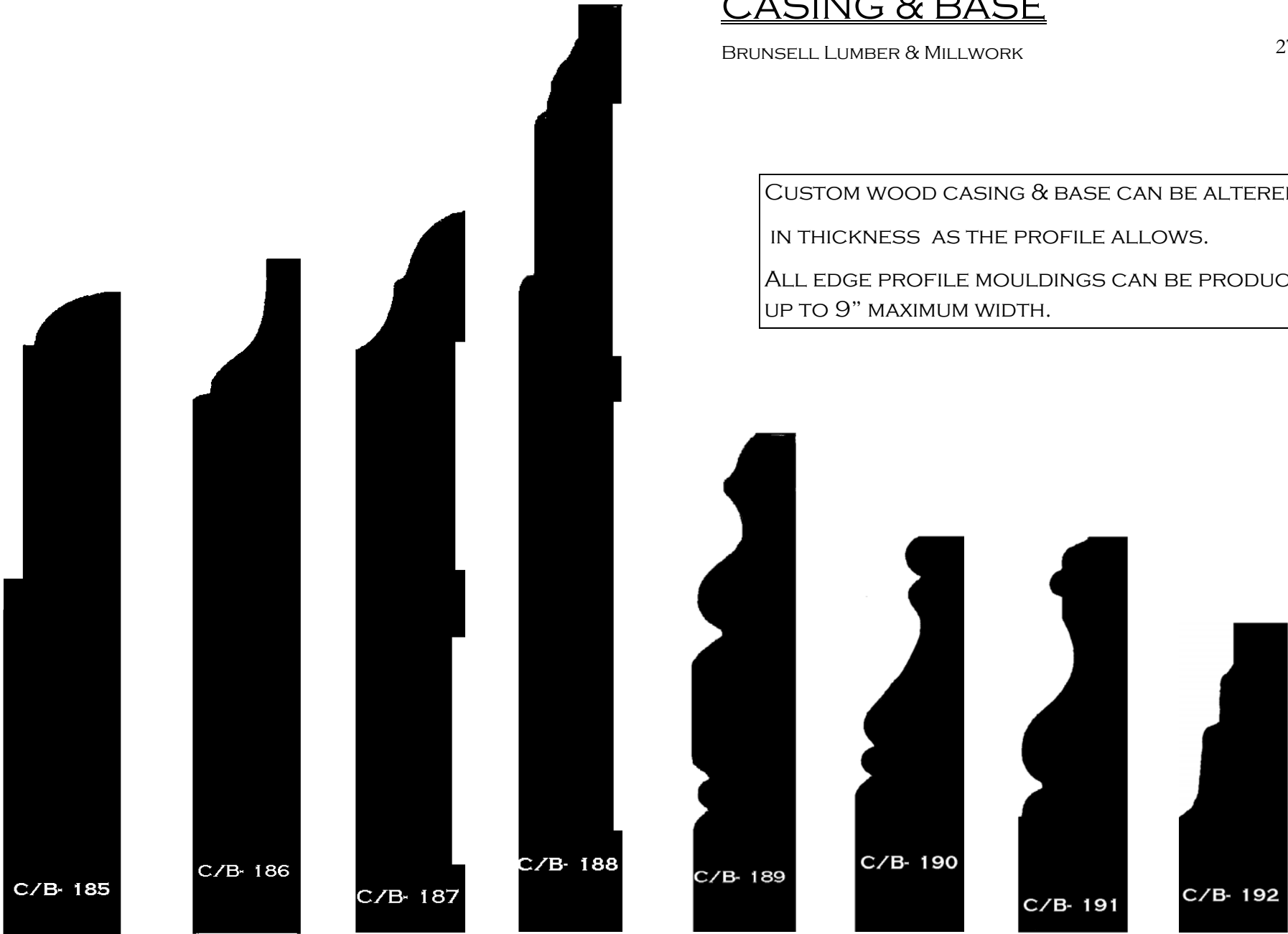

C/B-185 C/B-186 C/B-187 C/B-188 C/B-189 C/B-190 C/B-191 C/B-192
4 -3/4" 5" 5 -1/4" 6 -3/4" 3 -5/8" 2 -7/8" 2 -7/8" 2 -1/4"

CASING & BASE

BRUNSELL LUMBER & MILLWORK

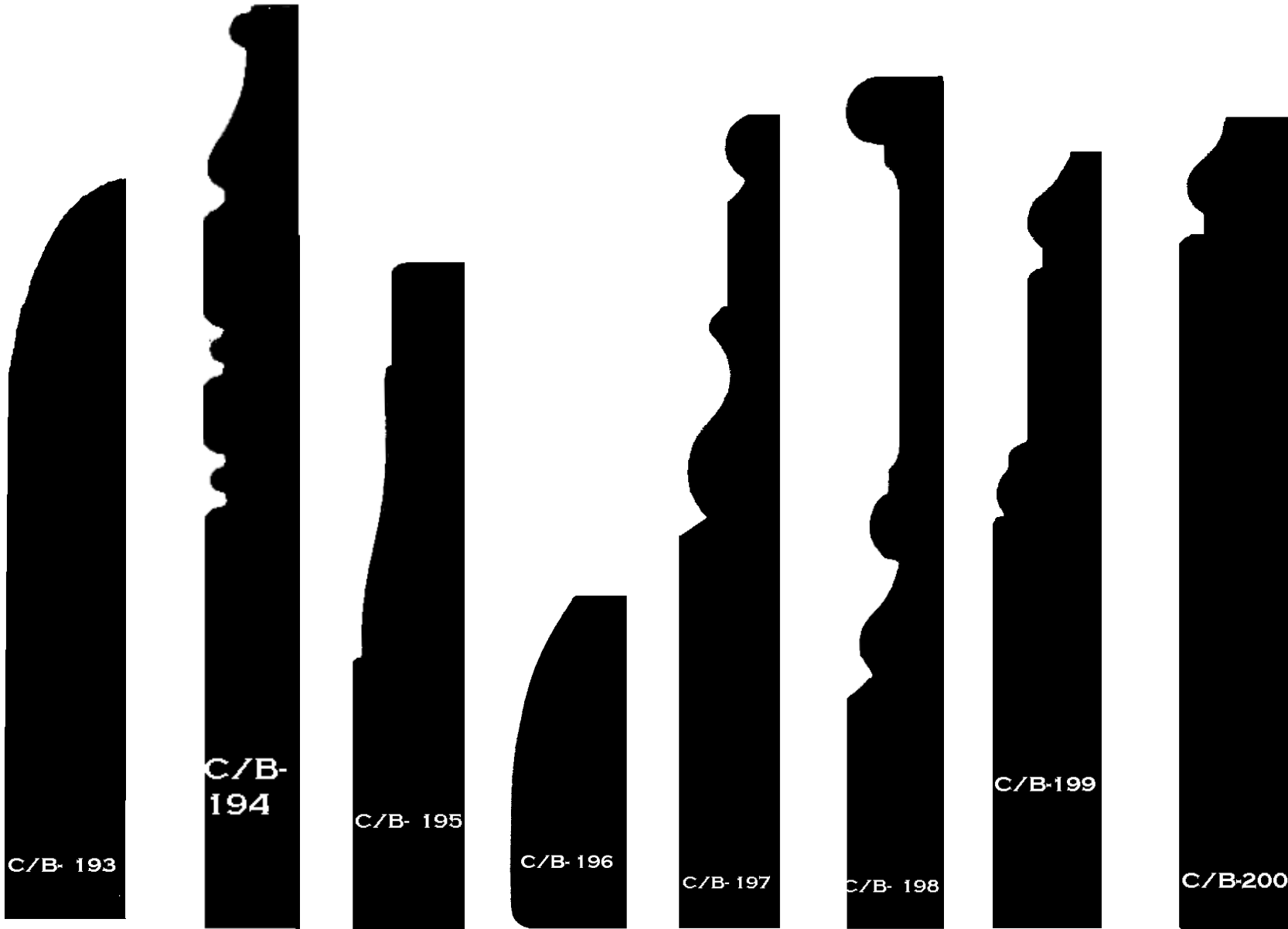

C/B-193	C/B-194	C/B-195	C/B-196	C/B-197	C/B-198	C/B-199	C/B-200
5"	6 -1/4"	4 -1/2"	2 -1/4"	5 -1/2"	5 -3/4"	5 -1/4"	5 -1/2"

CASING & BASE

BRUNSELL LUMBER & MILLWORK



CB-201



CB-202



CB-203

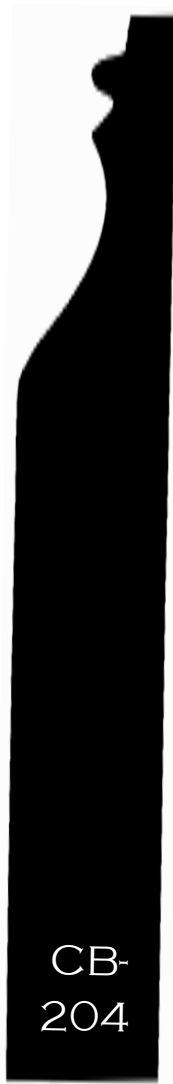

CB-204



CB-205



CB-206



CB-207



CB-208



CB-209

CB-201

9" MAX

CB-202

2-5/8"

CB-203

3-1/2"

CB-204

5-5/8"

CB-205

3-7/8"

CB-206

2-3/16"

CB-207

9" MAX

CB-208

9" MAX

CB-209

3-1/2"

CASING & BASE

BRUNSELL LUMBER & MILLWORK

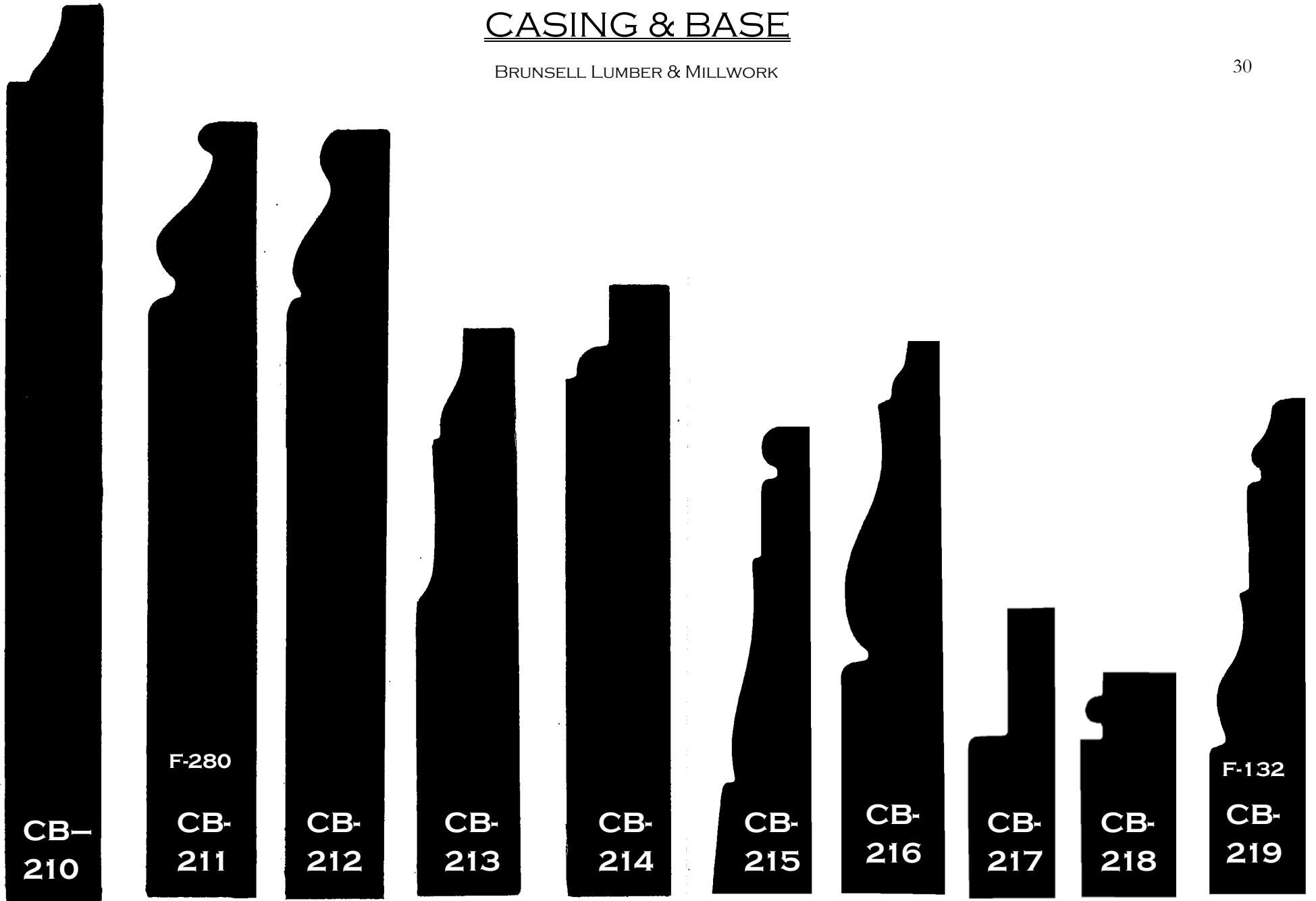

CB-210

CB-211

CB-212

CB-213

CB-214

CB-215

CB-216

CB-217

CB-218

CB-219

7"

6"

6"

4-3/8"

4-3/4"

3-5/8"

4-1/4"

2-1/2"

1-3/4"

3-7/8"

F-280

F-132

CASING & BASE

BRUNSELL LUMBER & MILLWORK

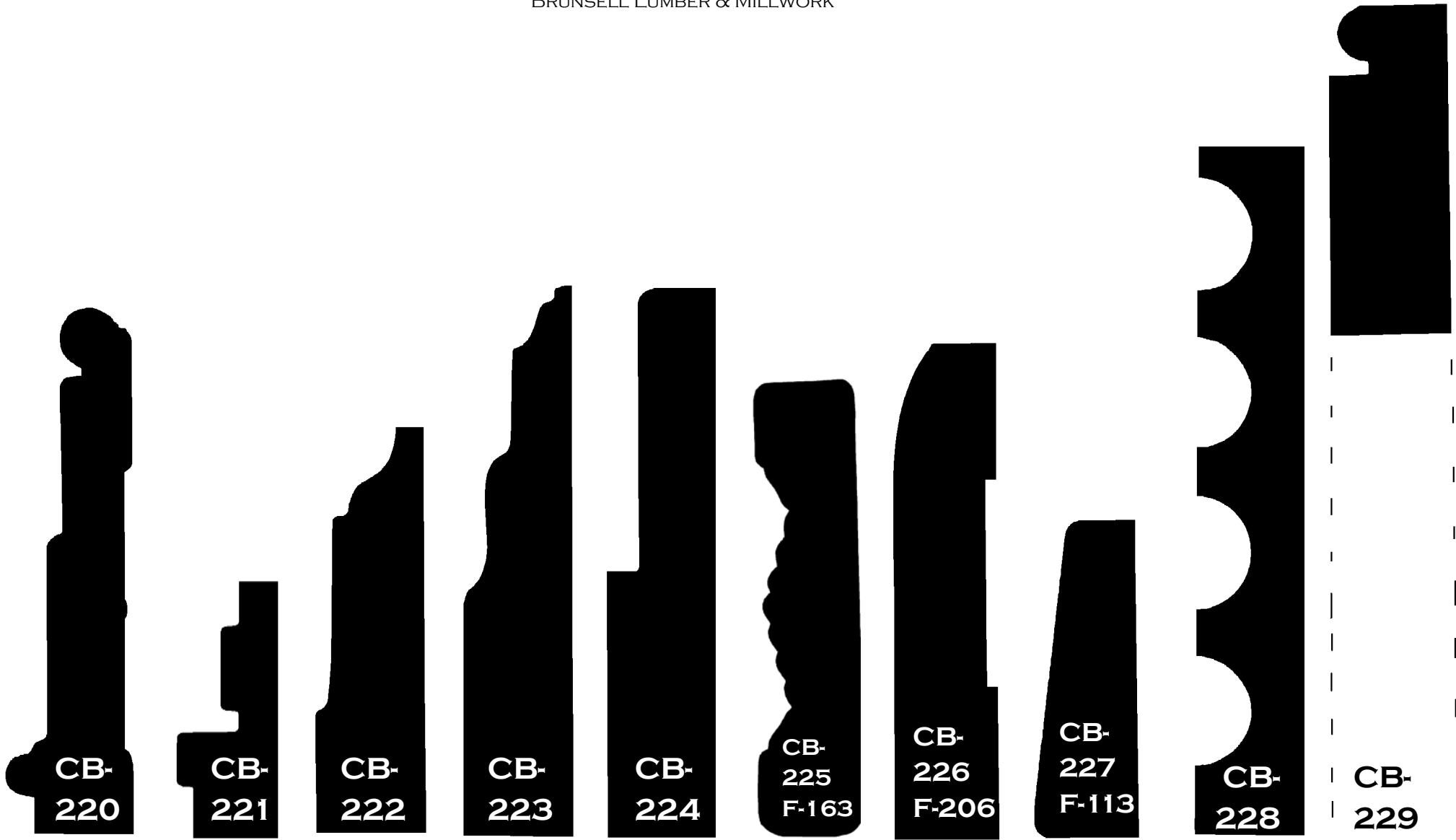

CB-220	CB-221	CB-222	CB-223	CB-224	CB-225	CB-226	CB-227	CB-228	CB-229
3-3/4"	1-15/16"	3"	4"	4"	3-1/4" F-163	3-5/8" F-206	2-1/4" F-113	5"	9" MAX

CASING & BASE

BRUNSELL LUMBER & MILLWORK

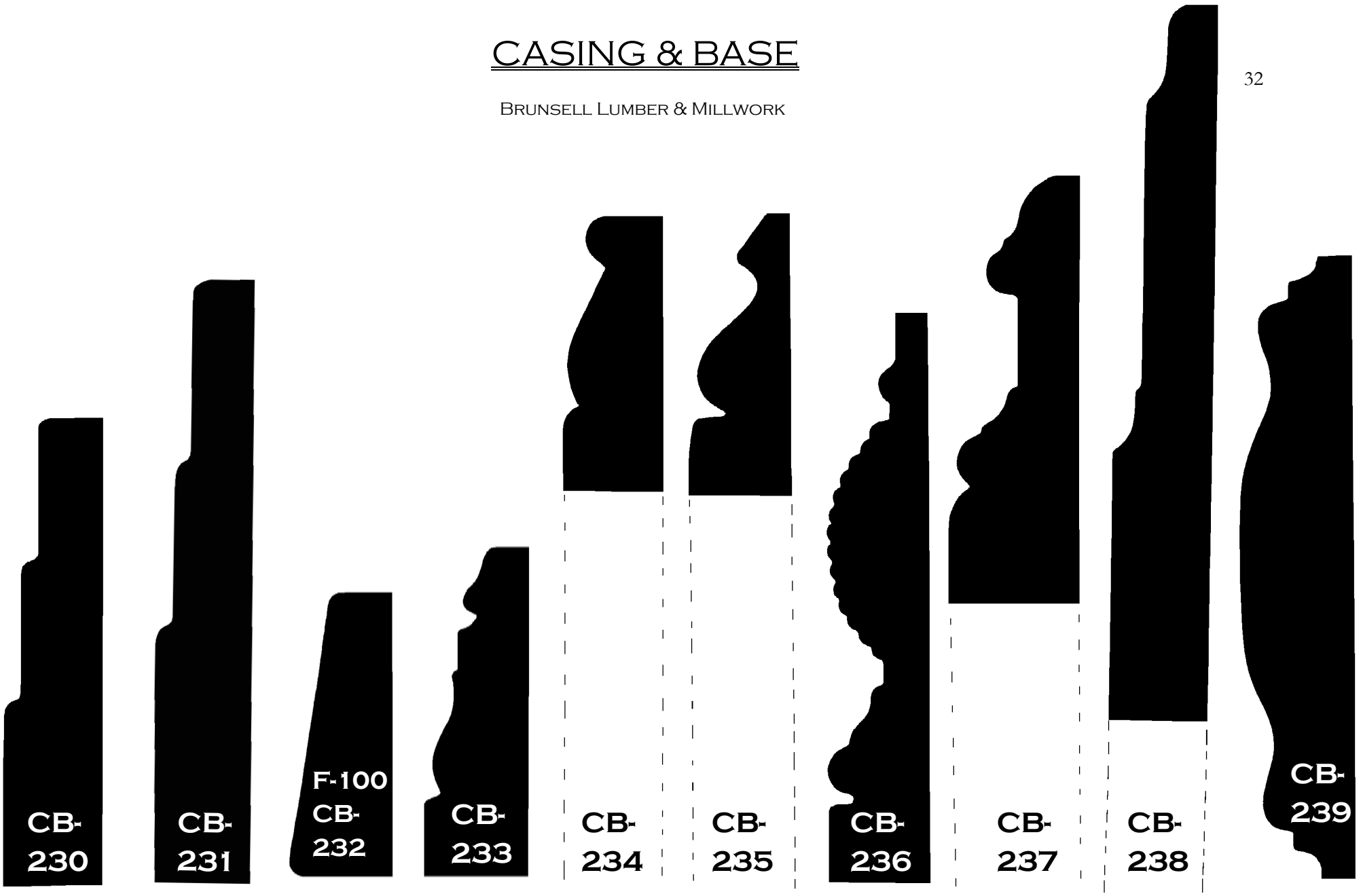

CB-230	CB-231	CB-232	CB-233	CB-234	CB-235	CB-236	CB-237	CB-238	CB-239
3-5/8"	4-5/8"	2-1/4" F-100	2-1/2"	9" MAX	9" MAX	4-3/8"	9" MAX	9" MAX	4-3/4"

CASING & BASE

BRUNSELL LUMBER & MILLWORK

CUSTOM WOOD CASING & BASE CAN BE ALTERED
IN THICKNESS AS THE PROFILE ALLOWS.
ALL EDGE PROFILE MOULDINGS CAN BE PRODUCED
UP TO 9" MAXIMUM WIDTH.



CB-240	CB-241	CB-242	CB-243	CB-244	CB-245	CB-246	CB-247	CB-248	CB-249
2-5/8"	3-3/4"	(SIDECUTTER)	2-7/8"		2-7/8"	3-3/8"	5-3/4"	9" MAX	5-1/2"

CASING & BASE

BRUNSELL LUMBER & MILLWORK

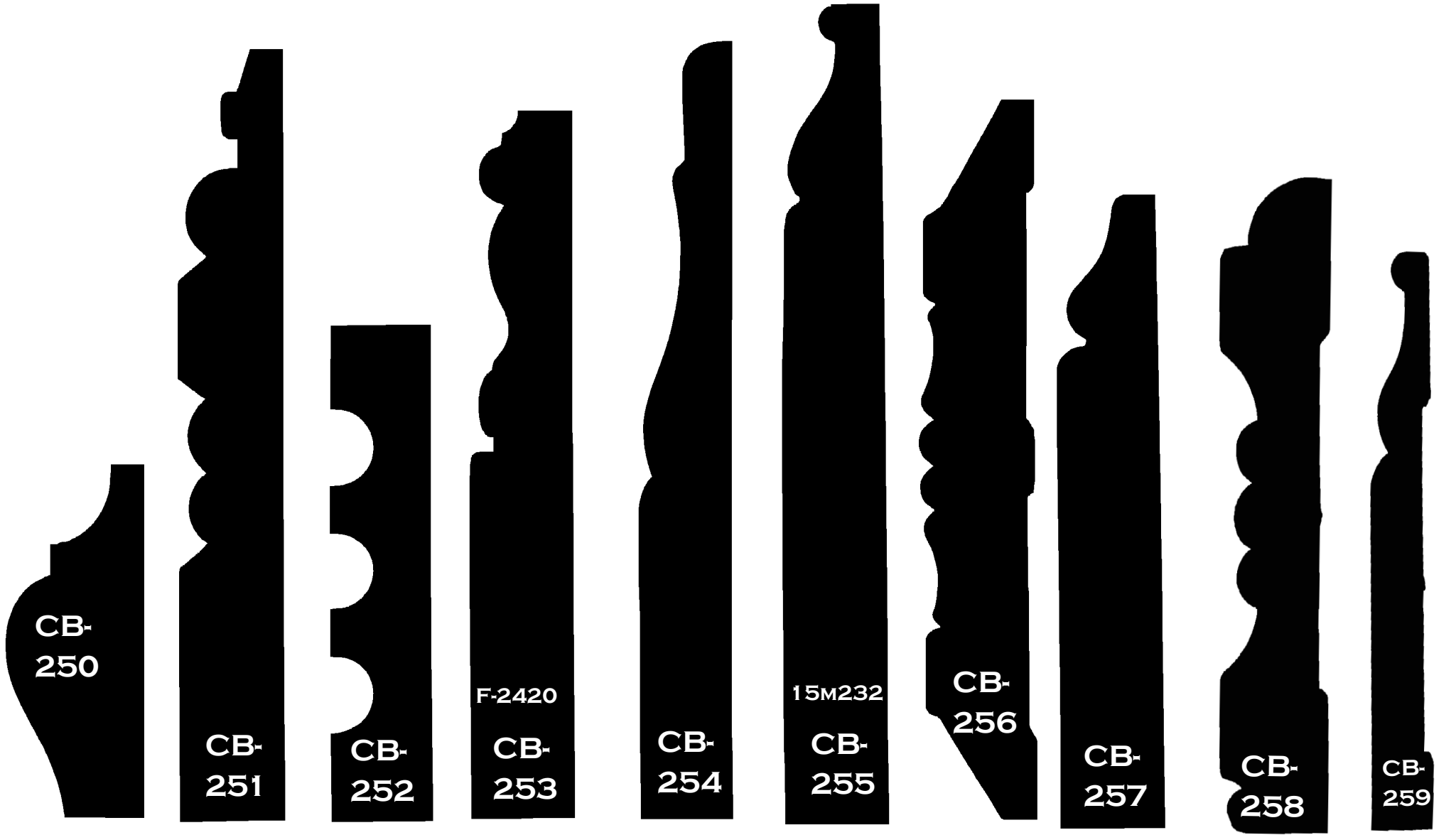

CB-250	CB-251	CB-252	CB-253	CB-254	CB-255	CB-256	CB-257	CB-258	CB-259
2-1/2"	5-5/8"	3-1/2"	5-1/4"	5-3/4"	6"	5-1/4"	4-5/8"	4-3/4"	4-1/4"
					15M232				

CASING & BASE

BRUNSELL LUMBER & MILLWORK



CB-260



CB-261



CB-262



CB-263



CB-264



CB-265



CB-266



CB-267



CB-268



CB-269

CB-260

4-1/4"

CB-261

2-3/8"

CB-262

4-1/8"

CB-263

3-1/8"

CB-264

1-3/4"

CB-265

3"

CB-266

5-1/4"

CB-267

3-1/2"

CB-268

3-1/2"

CB-269

6-1/2"

CASING & BASE

BRUNSELL LUMBER & MILLWORK

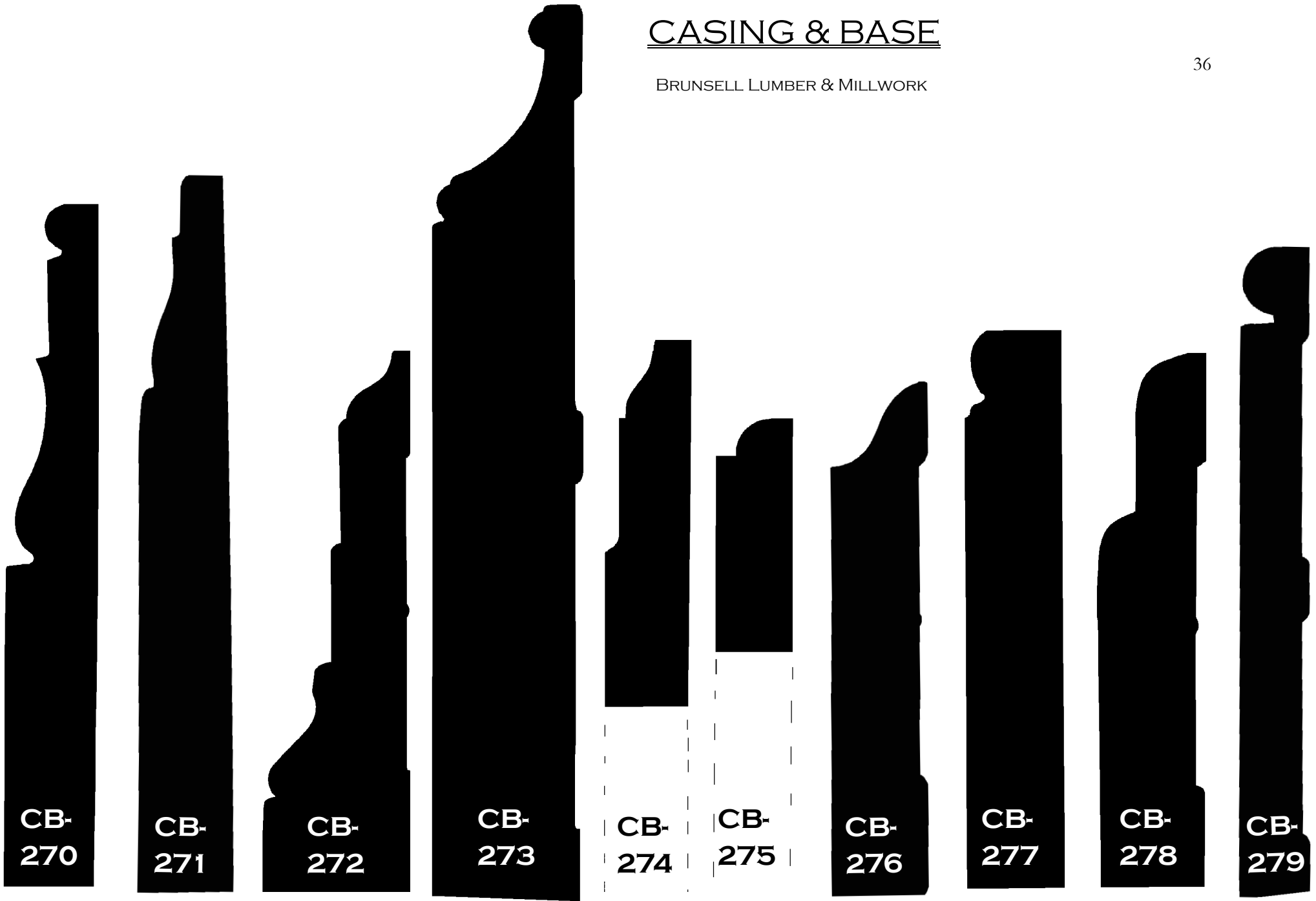

**CB-
270**

**CB-
271**

**CB-
272**

**CB-
273**

**CB-
274**

**CB-
275**

**CB-
276**

**CB-
277**

**CB-
278**

**CB-
279**

CB-270

CB-271

CB-272

CB-273

CB-274

CB-275

CB-276

CB-277

CB-278

CB-279

5-1/2"

5-3/4"

4-3/8"

7-1/4"

3"

2"

4-1/8"

4-1/2"

4-1/4"

5-1/4"

CASING & BASE

BRUNSELL LUMBER & MILLWORK

CUSTOM WOOD CASING & BASE CAN BE ALTERED
IN THICKNESS AS THE PROFILE ALLOWS.
ALL EDGE PROFILE MOULDINGS CAN BE PRODUCED
UP TO 9" MAXIMUM WIDTH.

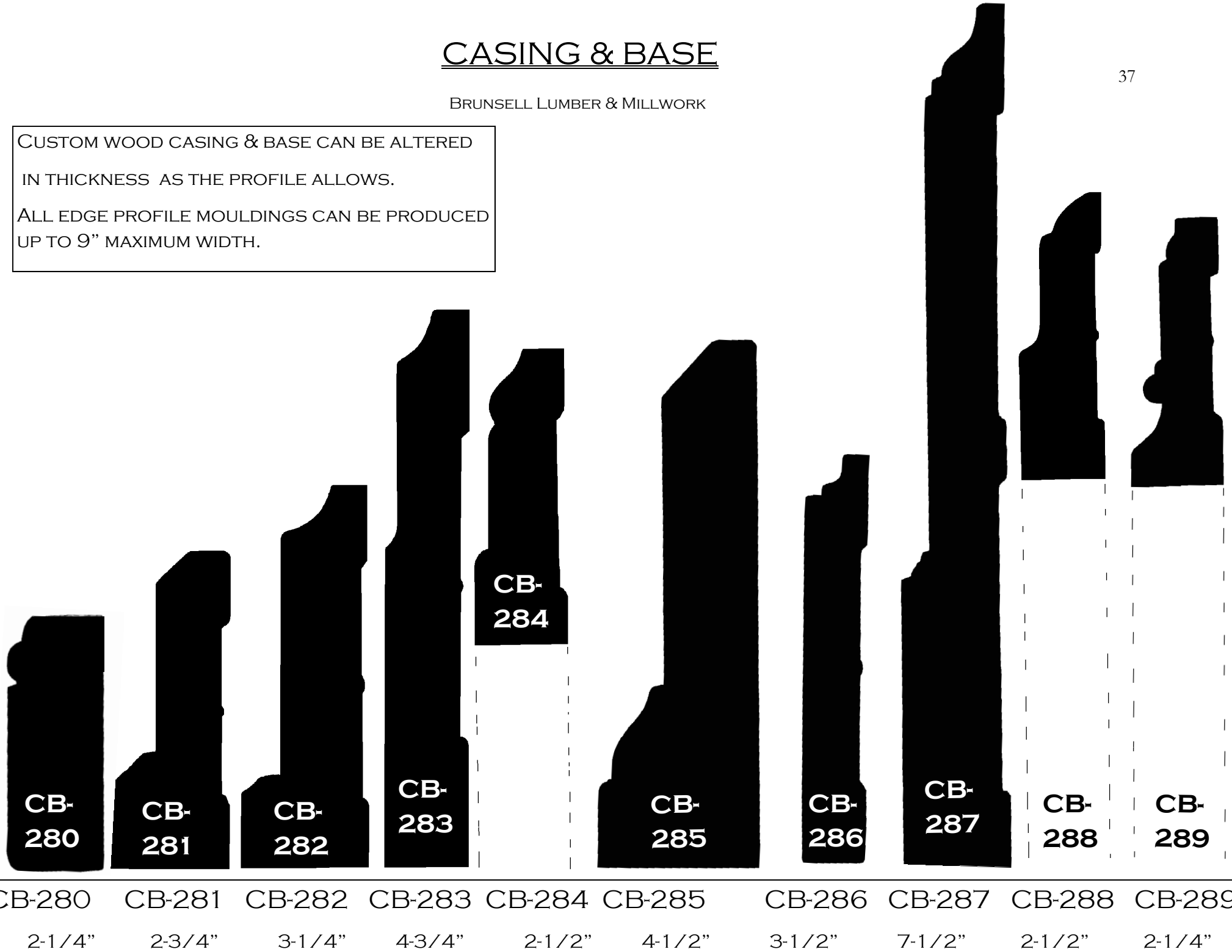

CASING & BASE

BRUNSELL LUMBER & MILLWORK

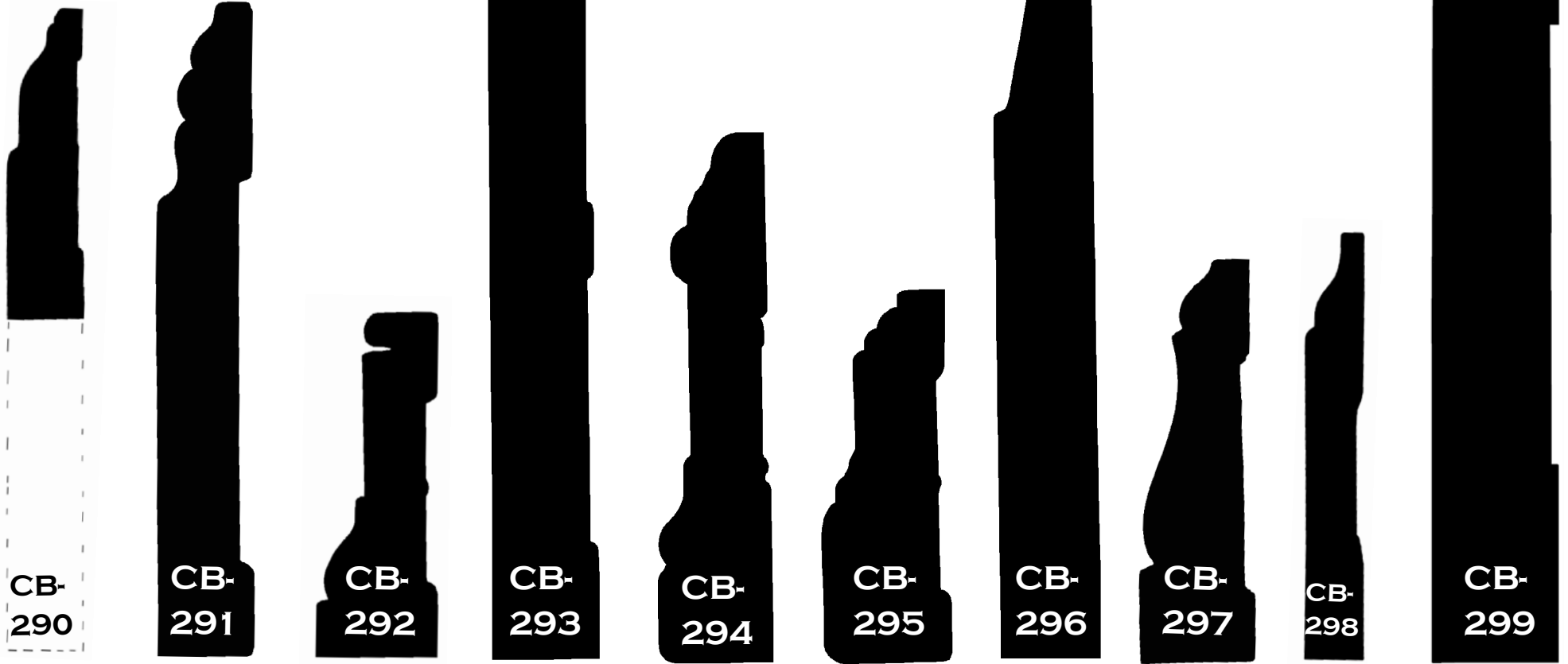

CB-290	CB-291	CB-292	CB-293	CB-294	CB-295	CB-296	CB-297	CB-298	CB-299
	4-1/4"	2-1/4"	5-1/2"	3-1/2"	2-1/2"	5"	2-5/8"	2-3/4"	6"

CASING & BASE

BRUNSELL LUMBER & MILLWORK

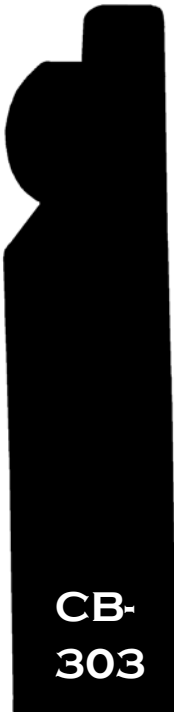

CB-300	CB-301	CB-302	CB-303	CB-304	CB-305	CB-306	CB-307	CB-308	CB-309
6"	6-1/8"	4-3/4"	3-3/4"	7-1/4"	2-1/2"	5-3/4"	4-1/2"	3-7/8"	4-3/8"

CASING & BASE

BRUNSELL LUMBER & MILLWORK

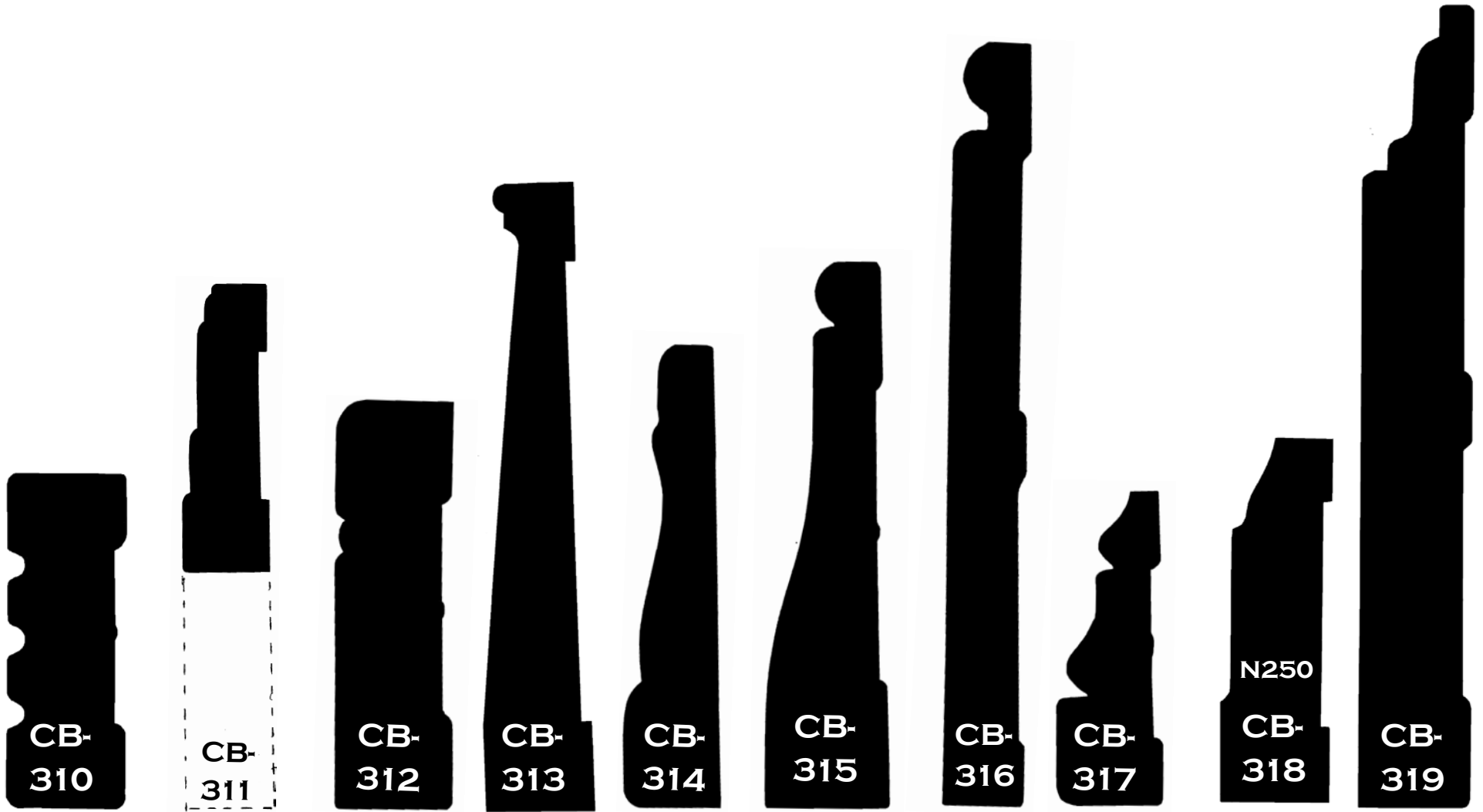

CB-310	CB-311	CB-312	CB-313	CB-314	CB-315	CB-316	CB-317	CB-318	CB-319
2-1/4"		2-3/4"	4-1/4"	3-1/8"	3-5/8"	5-1/8"	2-1/8"	2-1/2" N-250	5-3/8"

CASING & BASE

BRUNSELL LUMBER & MILLWORK

41

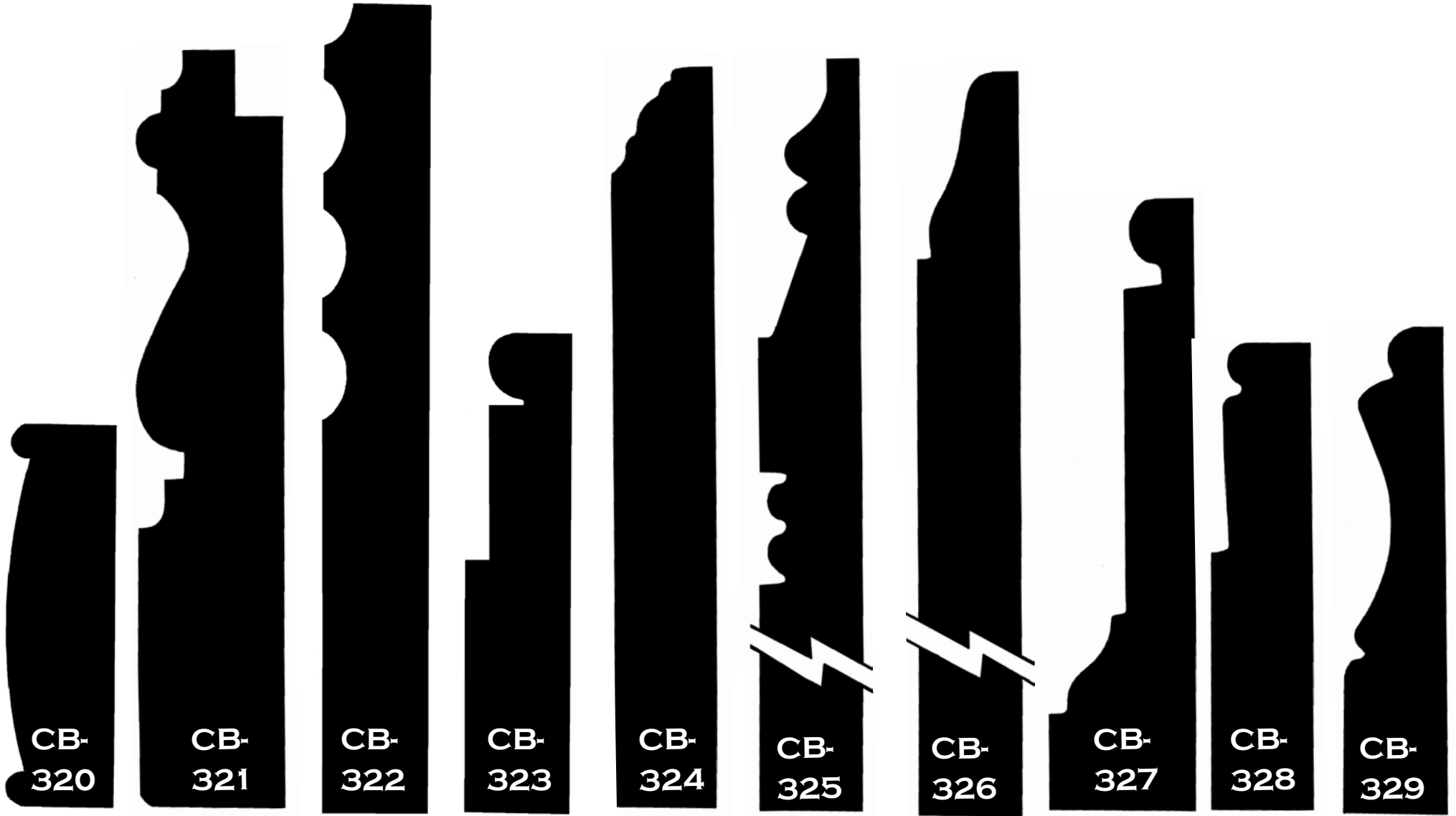

CB-320	CB-321	CB-322	CB-323	CB-324	CB-325	CB-326	CB-327	CB-328	CB-329
5-1/2"	2-3/4"	5-7/8"	3-3/8"	5-3/8"			4-3/8"	3-3/8"	3-1/2"

CASING & BASE

BRUNSELL LUMBER & MILLWORK

CUSTOM WOOD CASING & BASE CAN BE ALTERED
IN THICKNESS AS THE PROFILE ALLOWS.
ALL EDGE PROFILE MOULDINGS CAN BE PRODUCED
UP TO 9" MAXIMUM WIDTH.

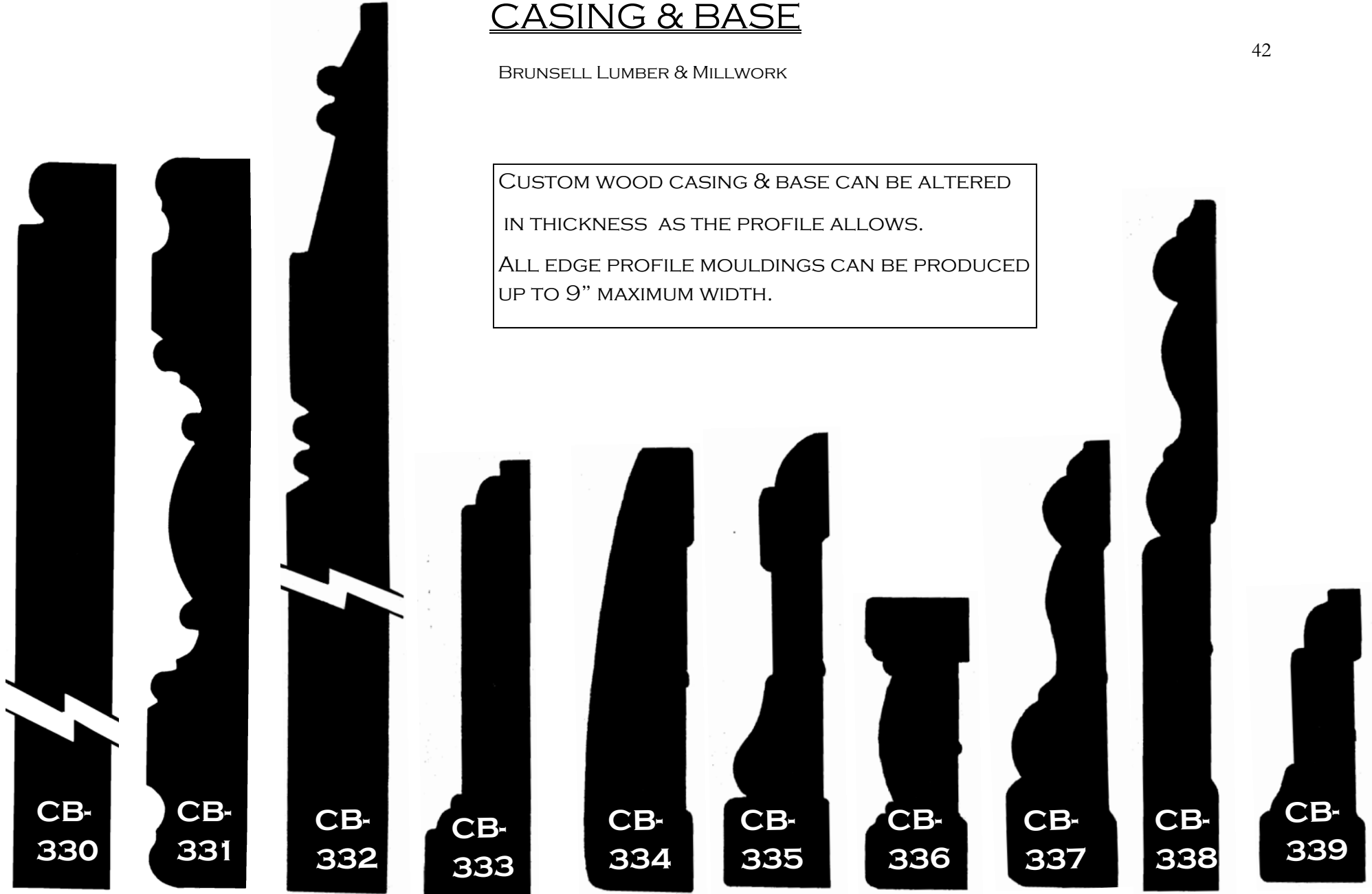

CB-330	CB-331	CB-332	CB-333	CB-334	CB-335	CB-336	CB-337	CB-338	CB-339
	5-1/2"		3-1/8"	3-1/4"	3-3/8"	2-1/8"	3-1/4"	5-1/8"	2-3/16"

CASING & BASE

BRUNSELL LUMBER & MILLWORK

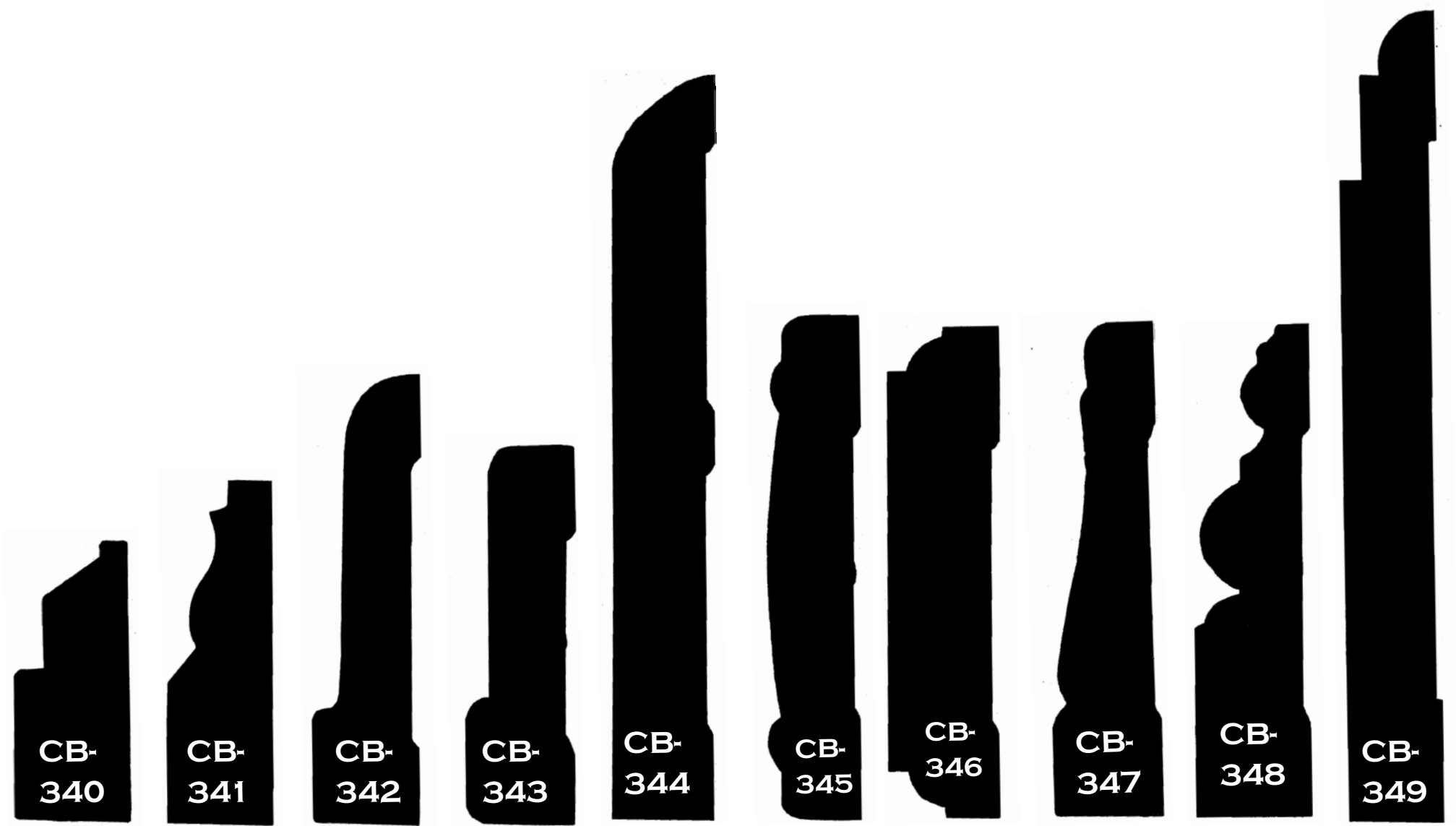

CB-340	CB-341	CB-342	CB-343	CB-344	CB-345	CB-346	CB-347	CB-348	CB-349
2"	2-1/2"	3-1/4"	2-3/4"	5-3/16"	3-5/8"	3-1/2"	3-1/2"	3-1/2"	6"

CASING & BASE

BRUNSELL LUMBER & MILLWORK



CB-350



CB-351



CB-352



PLINTH

CB-353



CB-354



CB-355



CB-356



CB-357



CB-358

CB-350

5"

CB-351

2-3/4"

CB-352

3"

CB-353

5-1/2"

PLINTH

CB-354

2-5/8"

CB-355

3-1/2"

CB-356

4- 3/8"

CB-357

2-3/8"

CB-358

4"

CASING & BASE

BRUNSELL LUMBER & MILLWORK

CUSTOM WOOD CASING & BASE CAN BE ALTERED
IN THICKNESS AS THE PROFILE ALLOWS.
ALL EDGE PROFILE MOULDINGS CAN BE PRODUCED
UP TO 9" MAXIMUM WIDTH.

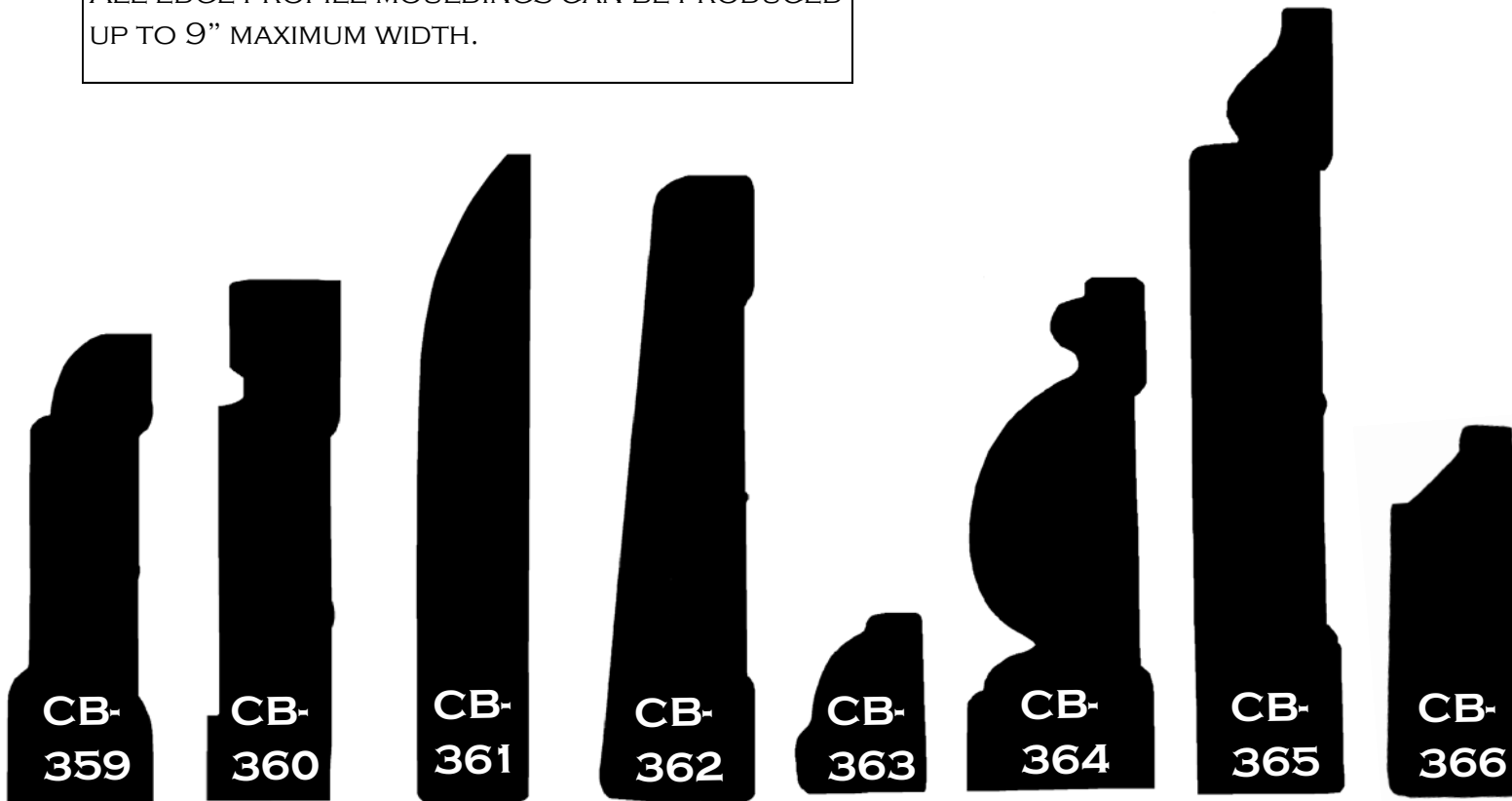

CB-359	CB-360	CB-361	CB-362	CB-363	CB-364	CB-365	CB-366
2-1/2"	2-3/4"	3-1/2"	3-1/4"	7/8"	2-3/4"	4-3/16"	2"

CASING & BASE

BRUNSELL LUMBER & MILLWORK

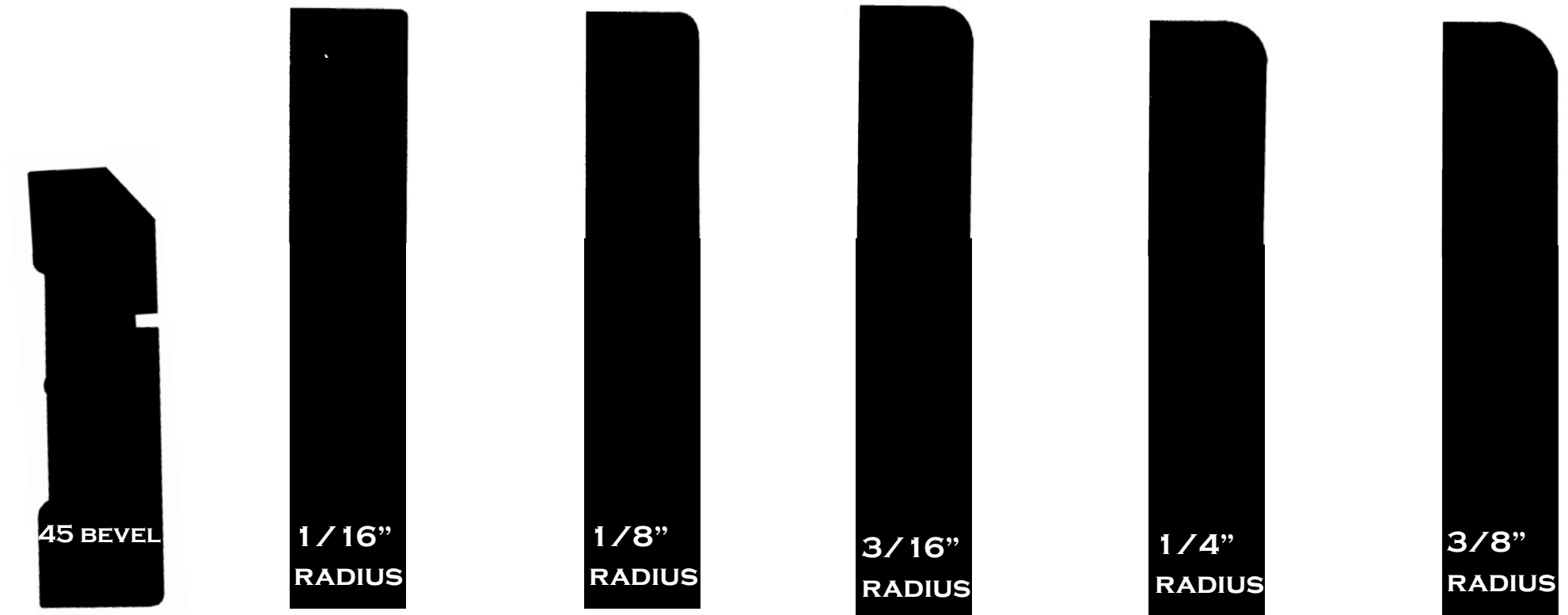

45 BEVEL

1/16"

1/8"

3/16"

1/4"

3/8"

W-1/8" KERF

RADIUS

RADIUS

RADIUS

RADIUS

RADIUS

1" DOWN FROM TOP

CASING & BASE

47

BRUNSELL LUMBER & MILLWORK

This page was intentionally left blank

CASING & BASE

48

BRUNSELL LUMBER & MILLWORK

This page was intentionally left blank

CURVED PROFILES

BRUNSELL LUMBER & MILLWORK

49

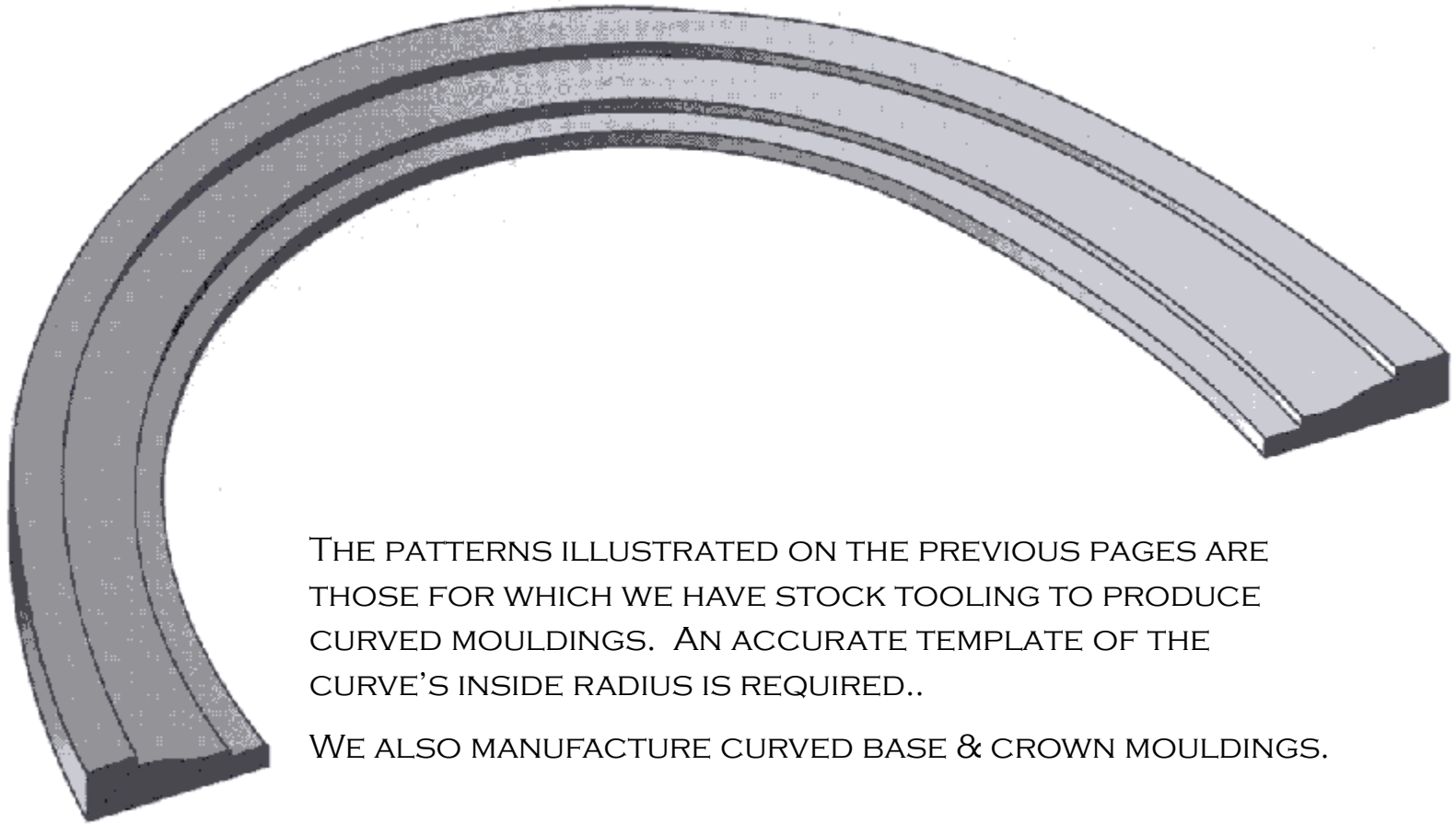

THE PATTERNS ILLUSTRATED ON THE PREVIOUS PAGES ARE THOSE FOR WHICH WE HAVE STOCK TOOLING TO PRODUCE CURVED MOULDINGS. AN ACCURATE TEMPLATE OF THE CURVE'S INSIDE RADIUS IS REQUIRED..

WE ALSO MANUFACTURE CURVED BASE & CROWN MOULDINGS.

PLEASE CONSULT YOUR BRUNSELL SALES ASSOCIATE FOR FURTHER INFORMATION.